

# TPS53353 Eco-mode™ 搭載、高効率 20A 同期降圧 SWIFT™ コンバータ

## 1 特長

- 新製品: **TPS548B28** リモート・センス機能搭載、**16V、20A** 同期降圧コンバータ
- 変換入力電圧範囲: 1.5V~15V
- VDD 入力電圧範囲: 4.5V~25V
- 20A において 12V から 1.5V への効率: 92%
- 出力電圧範囲: 0.6V~5.5V
- 5V LDO 出力
- 単一レール入力のサポート
- パワー MOSFET を内蔵 (連続出力電流 20A)
- 自動スキップ Eco-mode™ により軽負荷時の効率を向上
- シャットダウン時電流: 10μA 未満
- 高速過渡応答の D-CAP™ モード
- 外付け抵抗によりスイッチング周波数を 250kHz~1MHz の範囲で選択可能
- 自動スキップまたは PWM のみの動作を選択可能
- 1% 精度、0.6V の基準電圧を内蔵
- 内部電圧サーボ・ソフト・スタートを 0.7ms、1.4ms、2.8ms、5.6ms から選択可能
- ブースト・スイッチ内蔵
- プリチャージ付きスタートアップ機能
- 温度補償付きの調整可能な過電流制限
- 過電圧、低電圧、UVLO、過熱保護
- すべての出力コンデンサでセラミック・コンデンサの使用をサポート
- オープン・ドレインのパワー・グッド表示
- NexFET™ パワー・ブロック・テクノロジーを内蔵
- 22 ピン QFN パッケージ、PowerPAD™ 付き
- SWIFT™ パワー製品の技術資料については <http://www.ti.com/swift> を参照してください。

## 2 アプリケーション

- エンタープライズ・ラック・サーバー およびストレージ
- 有線ネットワーク・スイッチ および ルータ
- ASIC、SoC、FPGA、DSP コア、I/O 電圧

## 3 概要

TPS53353 は、MOSFET を内蔵した D-CAP™ モード 20A 同期スイッチャです。使いやすさに重点を置き、外部部品数の少ない省スペースの電源システム用に設計されています。

このデバイスには 5.5mΩ/2.2mΩ の MOSFET、1% 精度の 0.6V 基準電圧、ブースト・スイッチが内蔵されています。競合上の顕著な特長として、1.5V~15V の変換入力電圧範囲、非常に少ない外部部品数、D-CAP™ モード制御による超高速過渡応答、自動スキップ・モード動作、内部ソフト・スタート制御、選択可能な周波数、補償が不要、などが挙げられます。

変換入力電圧範囲は 1.5V~15V、電源電圧範囲は 4.5V~25V、出力電圧範囲は 0.6V~5.5V です。

このデバイスは 5mm × 6mm の 22 ピン QFN パッケージで供給され、-40°C~85°C で動作が規定されています。

TPS548B28 は、より小型の鉛フリー・パッケージを採用した、データ・センター・アプリケーション向けの新しい 20A デバイスです。

### 製品情報<sup>(1)</sup>

部品番号	パッケージ	本体サイズ (公称)
TPS53353	LSON-CLIP (22)	6.00mm × 5.00mm

- (1) 利用可能なすべてのパッケージについては、このデータシートの末尾にある注文情報を参照してください。

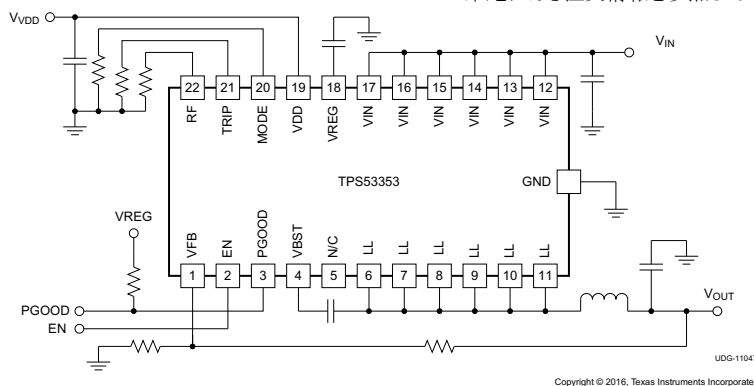

## アプリケーション概略



## Table of Contents

1 特長.....	1	7.4 Device Functional Modes.....	17
2 アプリケーション.....	1	<b>8 Application and Implementation.....</b>	<b>20</b>
3 概要.....	1	8.1 Application Information.....	20
4 Revision History.....	2	8.2 Typical Applications.....	20
5 Pin Configuration and Functions.....	3	<b>9 Power Supply Recommendations.....</b>	<b>29</b>
6 Specifications.....	4	<b>10 Layout.....</b>	<b>30</b>
6.1 Absolute Maximum Ratings <sup>(1)</sup> .....	4	10.1 Layout Guidelines.....	30
6.2 ESD Ratings.....	4	10.2 Layout Example.....	31
6.3 Recommended Operating Conditions.....	4	<b>11 Device and Documentation Support.....</b>	<b>32</b>
6.4 Thermal Information.....	5	11.1 Device Support.....	32
6.5 Electrical Characteristics.....	5	11.2 Receiving Notification of Documentation Updates..	32
6.6 Typical Characteristics.....	7	11.3 サポート・リソース.....	32
<b>7 Detailed Description.....</b>	<b>13</b>	11.4 Trademarks.....	32
7.1 Overview.....	13	11.5 静電気放電に関する注意事項.....	32
7.2 Functional Block Diagram.....	13	11.6 用語集.....	32
7.3 Feature Description.....	14		

## 4 Revision History

資料番号末尾の英字は改訂を表しています。その改訂履歴は英語版に準じています。

Changes from Revision C (December 2016) to Revision D (April 2021)	Page
• 「特長」に「グリーン (RoHS 準拠) を選択可能」を追加.....	1
• より小さいパッケージの新しい 20A デバイスとして <a href="#">TPS548B28</a> の情報を <a href="#">セクション 1</a> に追加.....	1
• 文書全体にわたって表、図、相互参照の採番方法を更新.....	1
• より小さいパッケージの新しい 20A デバイスとして <a href="#">TPS548B28</a> の情報を <a href="#">セクション 3</a> に追加.....	1
• Changed the EN waveform and overall delay time on <a href="#">図 7-1</a> and updated and moved the <a href="#">図 7-1</a> note into the <a href="#">セクション 7.3.1</a> description .....	14
• Added BST Resistor Selection to <a href="#">セクション 8.2.2.1</a> .....	24
• Added <a href="#">式 19</a> and supporting information.....	25
• MODE and RF pins updated in <a href="#">図 10-1</a> .....	31
Changes from Revision B (February 2015) to Revision C (February 2016)	Page
• 本データシートのタイトルを『TPS53353 High-Efficiency 20-A Synchronous Buck Converter With Eco-mode™』から『TPS53353 High-Efficiency 20-A Synchronous Buck SWIFT™ Converter With Eco-mode™』に変更.....	1
• <a href="#">セクション 1</a> :「SWIFT™ パワー製品の技術資料については ...」を追加.....	1
Changes from Revision A (April 2012) to Revision B (February 2015)	Page
• 「ピン構成および機能」セクション、「ESD 定格」表、「機能説明」セクション、「デバイスの機能モード」セクション、「アプリケーションと実装」セクション、「電源に関する推奨事項」セクション、「レイアウト」セクション、「デバイスおよびドキュメントのサポート」セクション、「メカニカル、パッケージ、および注文情報」セクションを追加.....	1
Changes from Revision Original (August 2011) to Revision A (April 2012)	Page
• 変換入力電圧を「3V」から「1.5V」に変更.....	1
• Changed VIN input voltage range minimum from "3 V" to "1.5 V".....	3
• Changed to correct typographical error in THERMAL INFORMATION table.....	4
• Changed VIN (main supply) input voltage range minimum from "3 V" to "1.5 V" in <a href="#">セクション 6.3</a> .....	4
• Changed conversion input voltage range from "3 V" to "1.5" in <a href="#">セクション 7.1</a> .....	13
• Added note to the <a href="#">セクション 7.3</a> .....	13
• Changed "ripple injection capacitor" to "ripple injection resistor" in the last bullet of the <i>Layout Guidelines</i> section.....	30

## 5 Pin Configuration and Functions

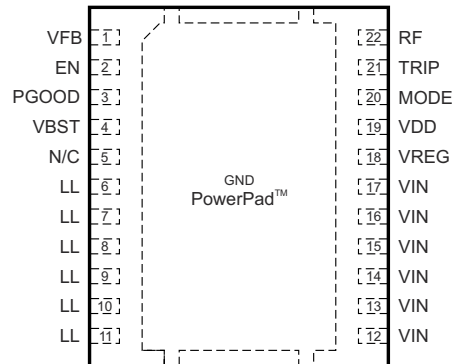

A. N/C = no connection

图 5-1. 22-Pins LSON-CLIP DQP Package (Top View)

表 5-1. Pin Functions

PIN		TYPE <sup>(1)</sup>	DESCRIPTION
NAME	NO.		
EN	2	I	Enable pin. Typical turnon threshold voltage is 1.2 V. Typical turnoff threshold voltage is 0.95 V.
GND		G	Ground and thermal pad of the device. Use proper number of vias to connect to ground plane.
LL	6	B	Output of converted power. Connect this pin to the output Inductor.
	7		
	8		
	9		
	10		
11			
MODE	20	I	Soft-start and Skip/CCM selection. Connect a resistor to select soft-start time using 表 7-3. The soft-start time is detected and stored into internal register during start-up.
N/C	5		No connect.
PGOOD	3	O	Open drain power good flag. Provides 1-ms start-up delay after VFB falls in specified limits. When VFB goes out of the specified limits PGOOD goes low after a 2-μs delay
RF	22	I	Switching frequency selection. Connect a resistor to GND or VREG to select switching frequency using 表 7-1. The switching frequency is detected and stored during the startup.
TRIP	21	I	OCL detection threshold setting pin. $I_{TRIP} = 10 \mu A$ at room temperature, 4700 ppm/°C current is sourced and set the OCL trip voltage as follows. $V_{OCL} = V_{TRIP} / 32$ ( $V_{TRIP} \leq 1.2 V$ , $V_{OCL} \leq 37.5 mV$ )
VBST	4	P	Supply input for high-side FET gate driver (boost terminal). Connect capacitor from this pin to LL node. Internally connected to VREG via bootstrap MOSFET switch.
VDD	19	P	Controller power supply input. VDD input voltage range is from 4.5 V to 25 V.
VFB	1	I	Output feedback input. Connect this pin to Vout through a resistor divider.
VIN	12	P	Conversion power input. The conversion input voltage range is from 1.5 V to 15 V.
	13		
	14		
	15		
	16		
17			
VREG	18	P	5-V low drop out (LDO) output. Supplies the internal analog circuitry and driver circuitry.

(1) I=Input, O=Output, B=Bidirectional, P=Supply, G=Ground

## 6 Specifications

### 6.1 Absolute Maximum Ratings<sup>(1)</sup>

		MIN	MAX	UNIT	
Input voltage range	VIN (main supply)	-0.3	25	V	
	VDD	-0.3	28		
	VBST	-0.3	32		
	VBST(with respect to LL)	-0.3	7		
	EN, TRIP, VFB, RF, MODE	-0.3	7		
Output voltage range	LL	DC	-2	25	V
		Pulse < 20ns, E=5 μJ	-7	27	
	PGOOD, VREG	-0.3	7		
	GND	-0.3	0.3		
Source/Sink current	VBST	50		mA	
Operating free-air temperature, T <sub>A</sub>		-40	85	°C	
Junction temperature, T <sub>J</sub>		-40	150		
Lead temperature 1,6 mm (1/16 inch) from case for 10 seconds			300		
Storage temperature, T <sub>stg</sub>		-55	150	°C	

- (1) Stresses beyond those listed under Absolute Maximum Ratings may cause permanent damage to the device. These are stress ratings only and functional operation of the device at these or any other conditions beyond those indicated under [セクション 6.3](#) is not implied. Exposure to absolute-maximum-rated conditions for extended periods may affect device reliability.

### 6.2 ESD Ratings

		VALUE	UNIT
V <sub>(ESD)</sub> Electrostatic discharge	Human-body model (HBM), per ANSI/ESDA/JEDEC JS-001 <sup>(1)</sup>	2000	V
	Charged-device model (CDM), per JEDEC specification JESD22-C101 <sup>(2)</sup>	500	

- (1) JEDEC document JEP155 states that 500-V HBM allows safe manufacturing with a standard ESD control process.  
(2) JEDEC document JEP157 states that 250-V CDM allows safe manufacturing with a standard ESD control process.

### 6.3 Recommended Operating Conditions

over operating free-air temperature range (unless otherwise noted)

		MIN	MAX	UNIT
Input voltage range	VIN (main supply)	1.5	15	V
	VDD	4.5	25	
	VBST	4.5	28	
	VBST(with respect to LL)	4.5	6.5	
	EN, TRIP, VFB, RF, MODE	-0.1	6.5	
Output voltage range	LL	-1	22	V
	PGOOD, VREG	-0.1	6.5	
Junction temperature range, T <sub>J</sub>		-40	125	°C

## 6.4 Thermal Information

THERMAL METRIC <sup>(1)</sup>		TPS53353	UNIT
		DQP (LSON-CLIP)	
		22 PINS	
$\theta_{JA}$	Junction-to-ambient thermal resistance	27.2	°C/W
$\theta_{JcTop}$	Junction-to-case (top) thermal resistance	17.1	
$\theta_{JB}$	Junction-to-board thermal resistance	5.9	
$\psi_{JT}$	Junction-to-top characterization parameter	0.8	
$\psi_{JB}$	Junction-to-board characterization parameter	5.8	
$\theta_{JcBot}$	Junction-to-case (bottom) thermal resistance	1.2	

(1) For more information about traditional and new thermal metrics, see the [Semiconductor and IC Package Thermal Metrics](#) application report.

## 6.5 Electrical Characteristics

Over recommended free-air temperature range,  $V_{VDD} = 12\text{ V}$  (unless otherwise noted)

PARAMETER		CONDITIONS	MIN	TYP	MAX	UNIT
<b>SUPPLY CURRENT</b>						
$V_{VIN}$	VIN pin power conversion input voltage		1.5		15	V
$V_{VDD}$	Supply input voltage		4.5		25	V
$I_{VIN(Leak)}$	VIN pin leakage current	$V_{EN} = 0\text{ V}$			1	$\mu\text{A}$
$I_{VDD}$	VDD supply current	$T_A = 25^\circ\text{C}$ , No load, $V_{EN} = 5\text{ V}$ , $V_{VFB} = 0.630\text{ V}$		420	590	$\mu\text{A}$
$I_{VDDSDN}$	VDD shutdown current	$T_A = 25^\circ\text{C}$ , No load, $V_{EN} = 0\text{ V}$			10	$\mu\text{A}$
<b>INTERNAL REFERENCE VOLTAGE</b>						
$V_{VFB}$	VFB regulation voltage	CCM condition <sup>(1)</sup>		0.6		V
$V_{VFB}$	VFB regulation voltage	$T_A = 25^\circ\text{C}$	0.597	0.6	0.603	V
		$0^\circ\text{C} \leq T_A \leq 85^\circ\text{C}$	0.5952	0.6	0.6048	
		$-40^\circ\text{C} \leq T_A \leq 85^\circ\text{C}$	0.594	0.6	0.606	
$I_{VFB}$	VFB input current	$V_{VFB} = 0.630\text{ V}$ , $T_A = 25^\circ\text{C}$		0.01	0.2	$\mu\text{A}$
<b>LDO OUTPUT</b>						
$V_{VREG}$	LDO output voltage	$0\text{ mA} \leq I_{VREG} \leq 30\text{ mA}$	4.77	5	5.36	V
$I_{VREG}$	LDO output current <sup>(1)</sup>	Maximum current allowed from LDO			30	mA
$V_{DO}$	Low drop out voltage	$V_{VDD} = 4.5\text{ V}$ , $I_{VREG} = 30\text{ mA}$			230	mV
<b>BOOT STRAP SWITCH</b>						
$V_{FBST}$	Forward voltage	$V_{VREG-VBST}$ , $I_F = 10\text{ mA}$ , $T_A = 25^\circ\text{C}$		0.1	0.2	V
$I_{VBSTLK}$	VBST leakage current	$V_{VBST} = 23\text{ V}$ , $V_{SW} = 17\text{ V}$ , $T_A = 25^\circ\text{C}$		0.01	1.5	$\mu\text{A}$
<b>DUTY AND FREQUENCY CONTROL</b>						
$t_{OFF(min)}$	Minimum off time	$T_A = 25^\circ\text{C}$	150	260	400	ns
$t_{ON(min)}$	Minimum on time	$V_{IN} = 17\text{ V}$ , $V_{OUT} = 0.6\text{ V}$ , $R_{RF} = 39\text{ k}\Omega$ , $T_A = 25^\circ\text{C}$ <sup>(1)</sup>		35		ns
<b>SOFT START</b>						
$t_{SS}$	Internal soft-start time from $V_{OUT} = 0\text{ V}$ to 95% of $V_{OUT}$	$R_{MODE} = 39\text{ k}\Omega$		0.7		ms
		$R_{MODE} = 100\text{ k}\Omega$		1.4		
		$R_{MODE} = 200\text{ k}\Omega$		2.8		
		$R_{MODE} = 470\text{ k}\Omega$		5.6		
<b>INTERNAL MOSFETs</b>						
$R_{DS(on)H}$	High-side MOSFET on-resistance	$T_A = 25^\circ\text{C}$		5.5		m $\Omega$
$R_{DS(on)L}$	Low-side MOSFET on-resistance	$T_A = 25^\circ\text{C}$		2.2		

Over recommended free-air temperature range,  $V_{DD} = 12\text{ V}$  (unless otherwise noted)

PARAMETER		CONDITIONS	MIN	TYP	MAX	UNIT
<b>POWERGOOD</b>						
$V_{THPG}$	PG threshold	PG in from lower	92.5%	95%	98.5%	
		PG in from higher	107.5%	110%	112.5%	
		PG hysteresis	2.5%	5%	7.5%	
$R_{PG}$	PG transistor on-resistance		15	30	55	$\Omega$
$t_{PGDEL}$	PG delay	Delay for PG in	0.8	1	1.2	ms
<b>LOGIC THRESHOLD AND SETTING CONDITIONS</b>						
$V_{EN}$	EN Voltage	Enable	1.8			V
		Disable			0.6	
$I_{EN}$	EN Input current	$V_{EN} = 5\text{ V}$			1	$\mu\text{A}$
$f_{SW}$	Switching frequency	$R_{RF} = 0\ \Omega$ to GND, $T_A = 25^\circ\text{C}^{(2)}$	200	250	300	kHz
		$R_{RF} = 187\text{ k}\Omega$ to GND, $T_A = 25^\circ\text{C}^{(2)}$	250	300	350	
		$R_{RF} = 619\text{ k}\Omega$ , to GND, $T_A = 25^\circ\text{C}^{(2)}$	350	400	450	
		$R_{RF} = \text{Open}$ , $T_A = 25^\circ\text{C}^{(2)}$	450	500	550	
		$R_{RF} = 866\text{ k}\Omega$ to VREG, $T_A = 25^\circ\text{C}^{(2)}$	580	650	720	
		$R_{RF} = 309\text{ k}\Omega$ to VREG, $T_A = 25^\circ\text{C}^{(2)}$	670	750	820	
		$R_{RF} = 124\text{ k}\Omega$ to VREG, $T_A = 25^\circ\text{C}^{(2)}$	770	850	930	
		$R_{RF} = 0\ \Omega$ to VREG, $T_A = 25^\circ\text{C}^{(2)}$	880	970	1070	
<b>PROTECTION: CURRENT SENSE</b>						
$I_{TRIP}$	TRIP source current	$V_{TRIP} = 1\text{ V}$ , $T_A = 25^\circ\text{C}$	9.4	10	10.6	$\mu\text{A}$
$T_{CITRIP}$	TRIP current temperature coefficient	On the basis of $25^\circ\text{C}^{(1)}$		4700		ppm/ $^\circ\text{C}$
$V_{TRIP}$	Current limit threshold setting range	$V_{TRIP-GND}$	0.4		1.2	V
$V_{OCL}$	Current limit threshold	$V_{TRIP} = 1.2\text{ V}$	32	37.5	43	mV
		$V_{TRIP} = 0.4$	7.5	12.5	17.5	
$V_{OCLN}$	Negative current limit threshold	$V_{TRIP} = 1.2\text{ V}$	-160	-150	-140	mV
		$V_{TRIP} = 0.4\text{ V}$	-58	-50	-42	
$V_{AZCADJ}$	Auto zero cross adjustable range	Positive	3	15		mV
		Negative		-15	-3	
<b>PROTECTION: UVP and OVP</b>						
$V_{OVP}$	OVP trip threshold	OVP detect	115%	120%	125%	
$t_{OVPDEL}$	OVP propagation delay	VFB delay with 50-mV overdrive		1		$\mu\text{s}$
$V_{UVP}$	Output UVP trip threshold	UVP detect	65%	70%	75%	
$t_{UVPDEL}$	Output UVP propagation delay		0.8	1	1.2	ms
$t_{UVPEN}$	Output UVP enable delay	From enable to UVP workable	1.8	2.6	3.2	ms
<b>UVLO</b>						
$V_{UVVREG}$	VREG UVLO threshold	Wake up	4	4.2	4.33	V
		Hysteresis		0.25		
<b>THERMAL SHUTDOWN</b>						
$T_{SDN}$	Thermal shutdown threshold	Shutdown temperature <sup>(1)</sup>		145		$^\circ\text{C}$
		Hysteresis <sup>(1)</sup>		10		

(1) Ensured by design. Not production tested.

(2) Not production tested. Test condition is  $V_{IN} = 12\text{ V}$ ,  $V_{OUT} = 1.1\text{ V}$ ,  $I_{OUT} = 10\text{ A}$  using application circuit shown in [Figure 8-1](#).

## 6.6 Typical Characteristics

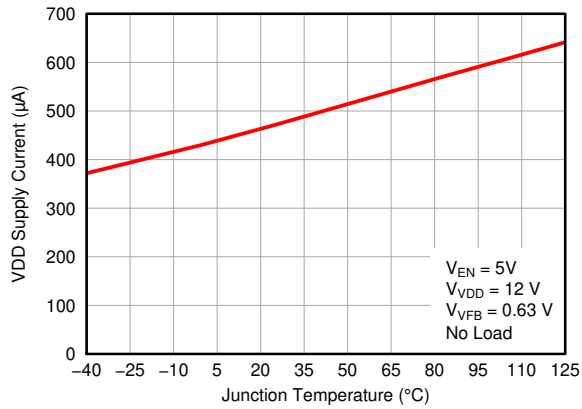

6-1. VDD Supply Current vs. Junction Temperature

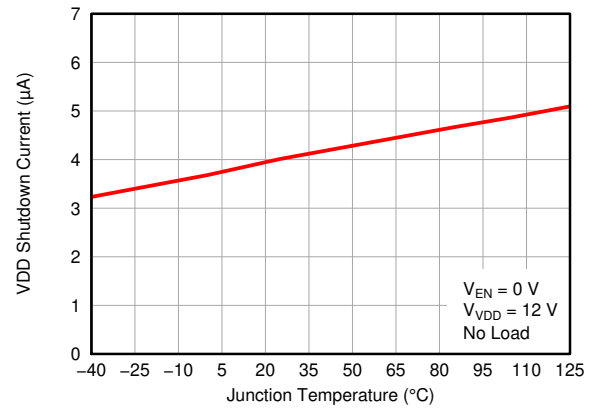

6-2. VDD Shutdown Current vs. Junction Temperature

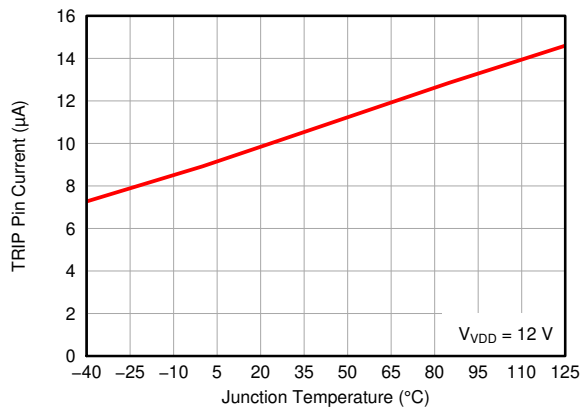

6-3. TRIP Pin Current vs. Junction Temperature

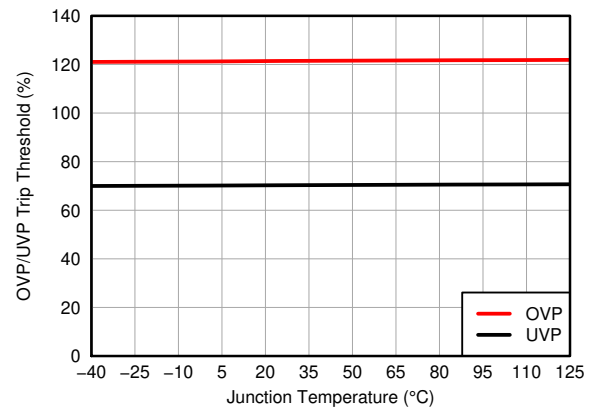

6-4. OVP/UVP Trip Threshold vs. Junction Temperature

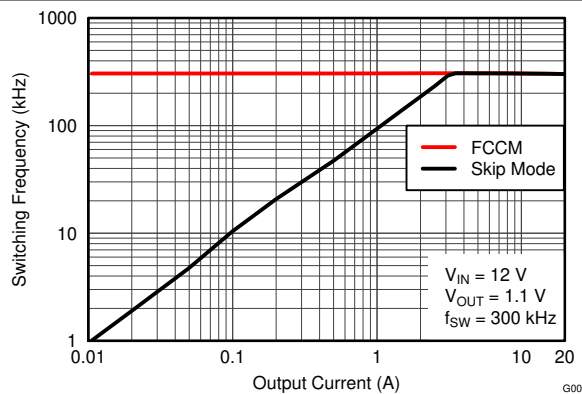

6-5. Switching Frequency vs. Output Current

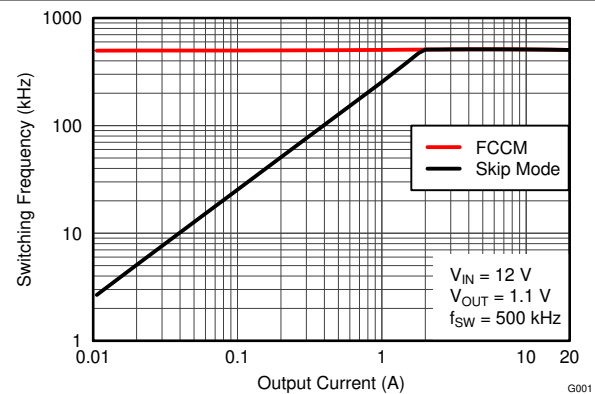

6-6. Switching Frequency vs. Output Current

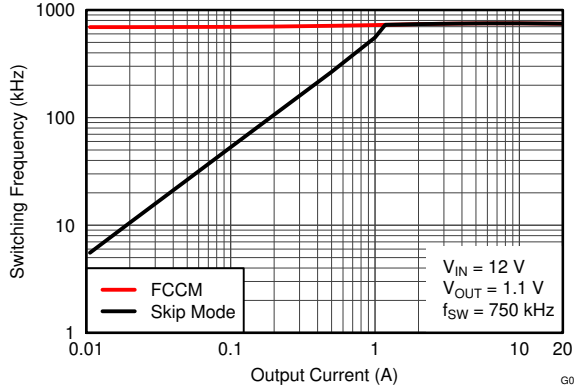

**6-7. Switching Frequency vs. Output Current**

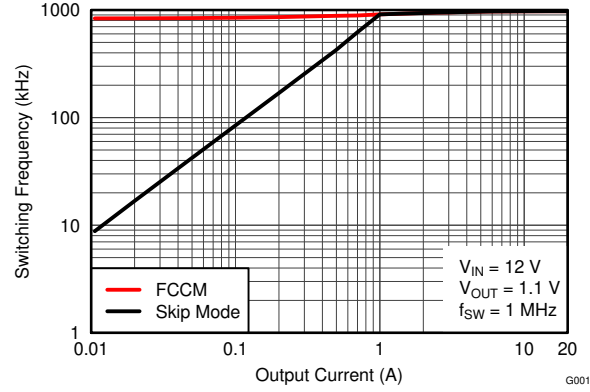

**6-8. Switching Frequency vs. Output Current**

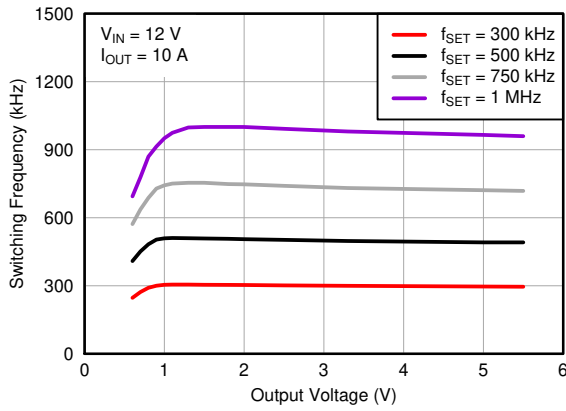

**6-9. Switching Frequency vs. Output Voltage**

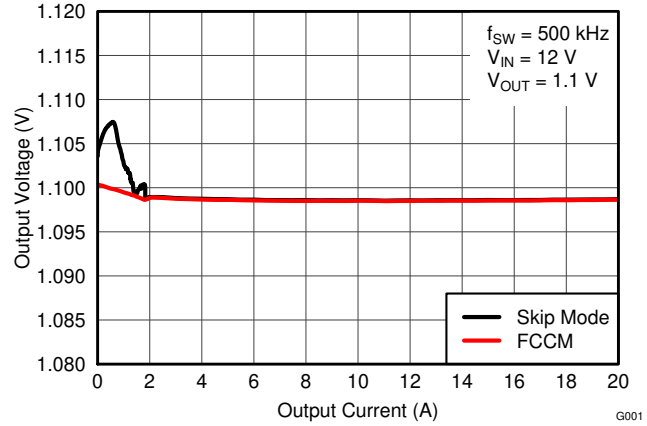

**6-10. Output Voltage vs. Output Current**

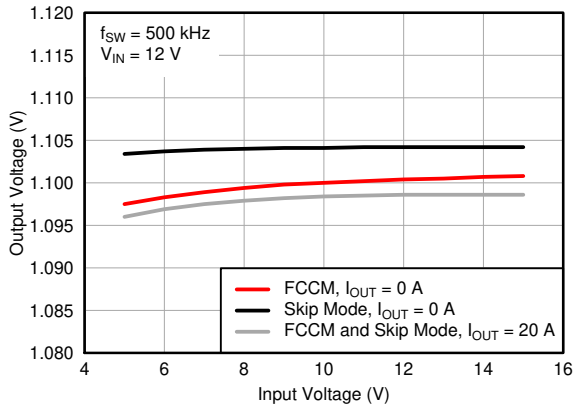

**6-11. Output Voltage vs. Input Voltage**

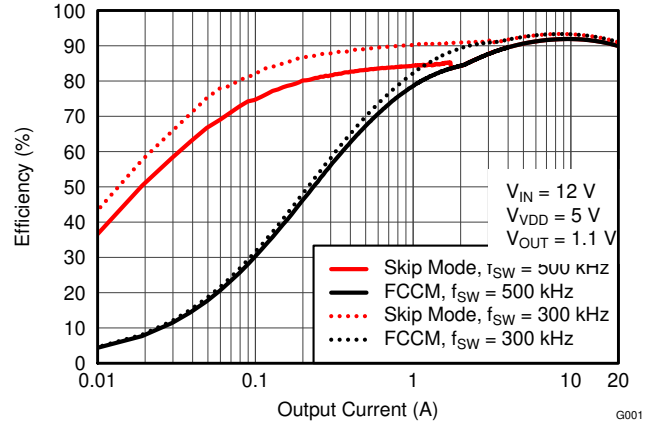

**6-12. Efficiency vs. Output Current**



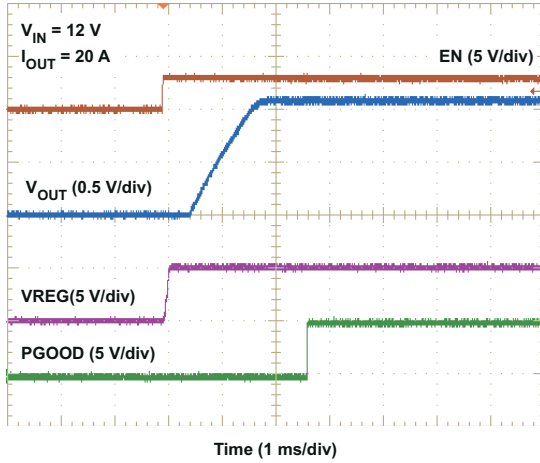

**6-13. Start-Up Waveforms**

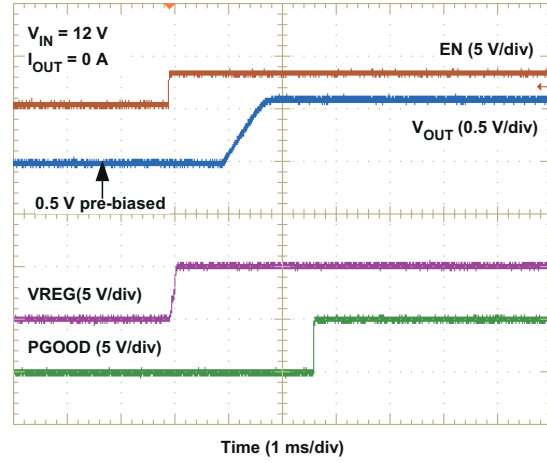

**6-14. Prebias Start-Up Waveforms**

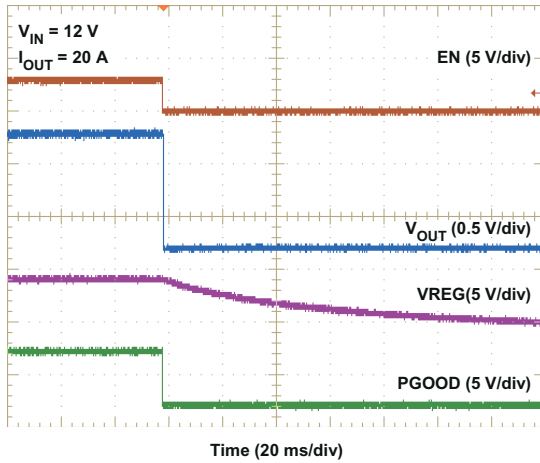

**6-15. Shutdown Waveforms**

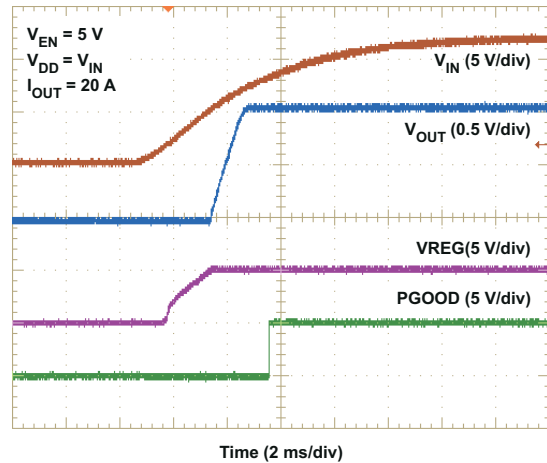

**6-16. UVLO Start-Up Waveforms**

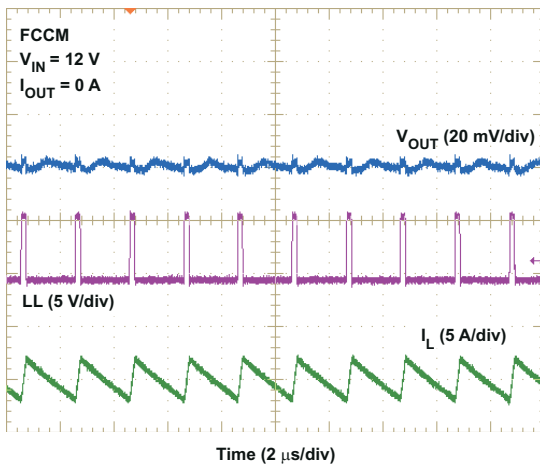

**6-17. 1.1-V Output FCCM Mode Steady-State Operation**

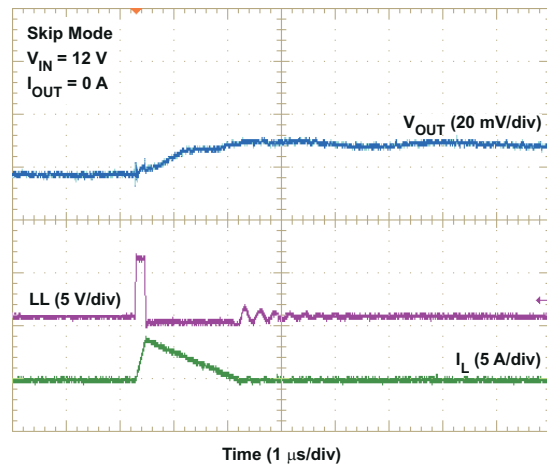

**6-18. 1.1-V Output Skip Mode Steady-State Operation**

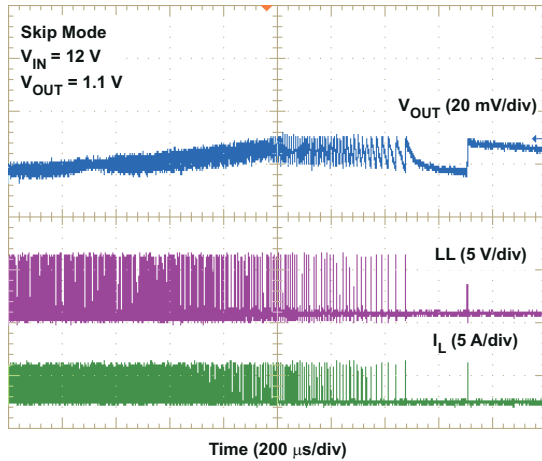

6-19. CCM-to-DCM Transition Waveforms

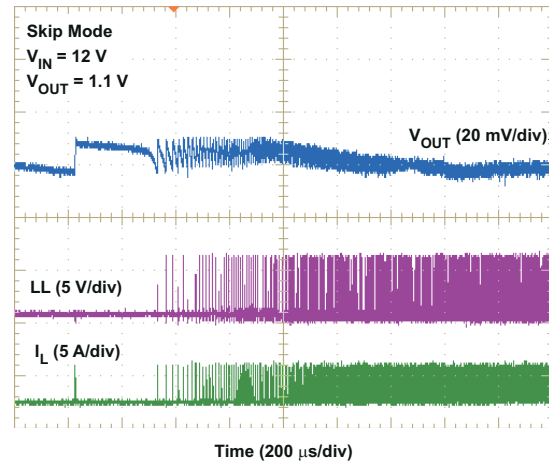

6-20. DCM-to-CCM Transition Waveforms

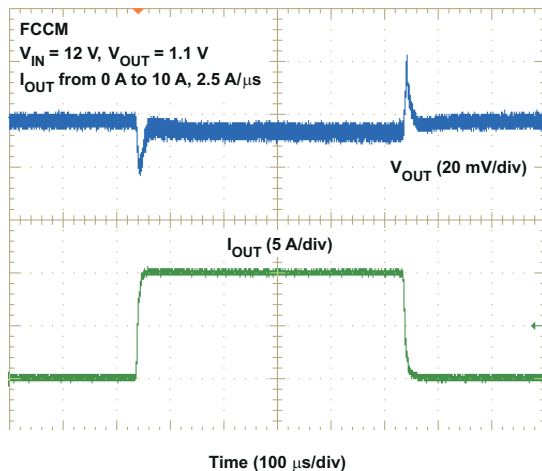

6-21. FCCM Load Transient

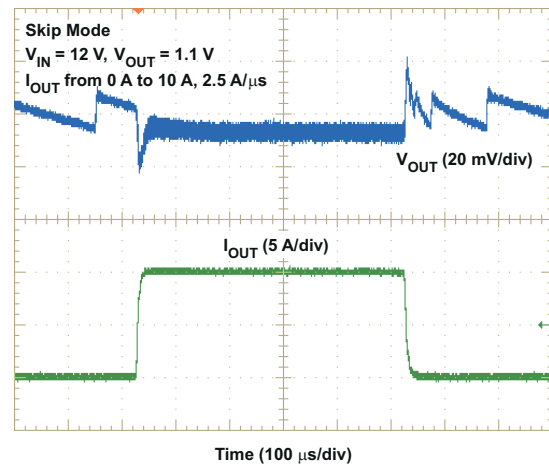

6-22. Skip Mode Load Transient

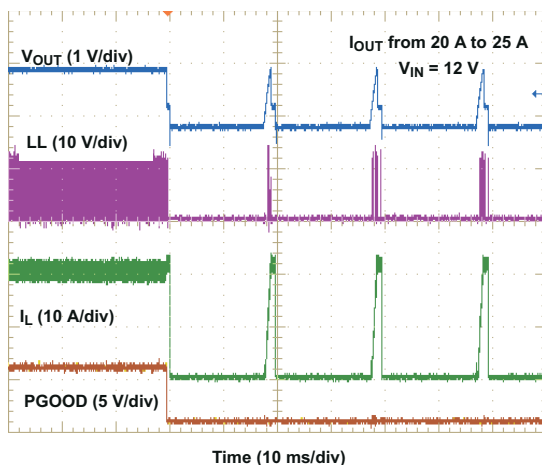

6-23. Overcurrent Protection Waveforms

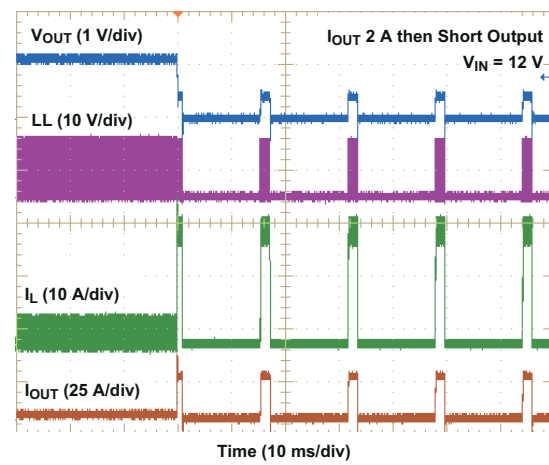

6-24. Output Short-Circuit Protection Waveforms

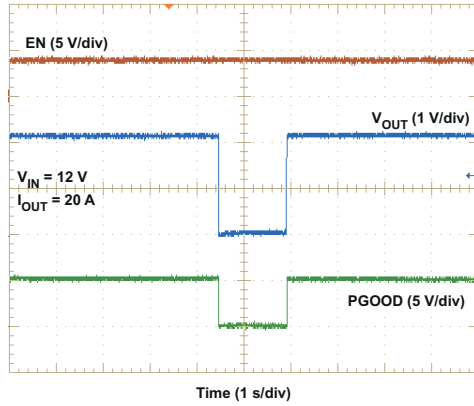

6-25. Overtemperature Protection Waveforms

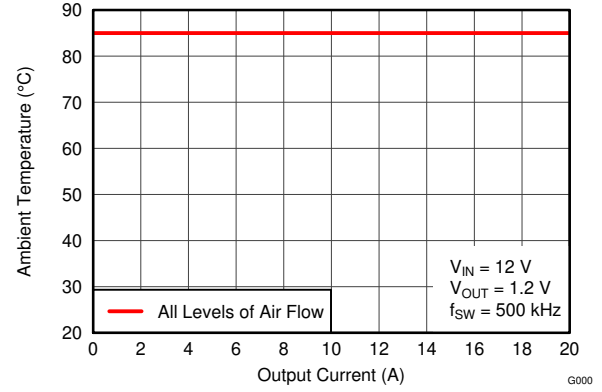

6-26. Safe Operating Area

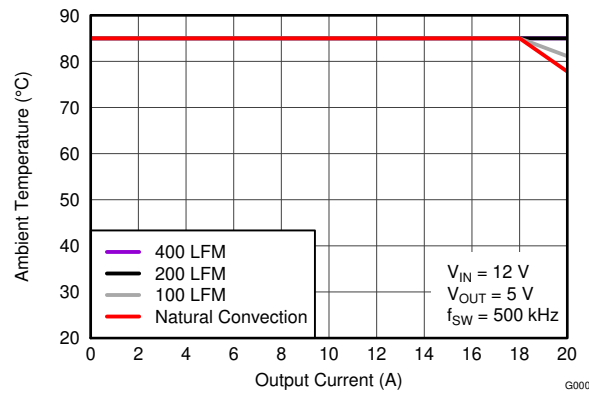

6-27. Safe Operating Area

For  $V_{OUT} = 5\text{ V}$ , an SC5026-1R0 inductor is used. For  $1 \leq V_{OUT} \leq 3.3\text{ V}$ , a PA0513.441 inductor is used

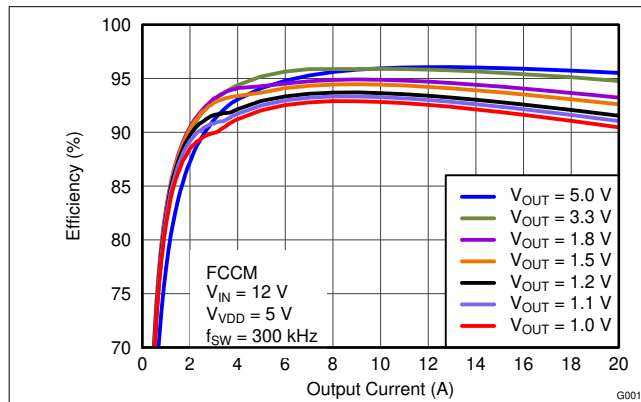

**6-28. Efficiency vs Output Current**

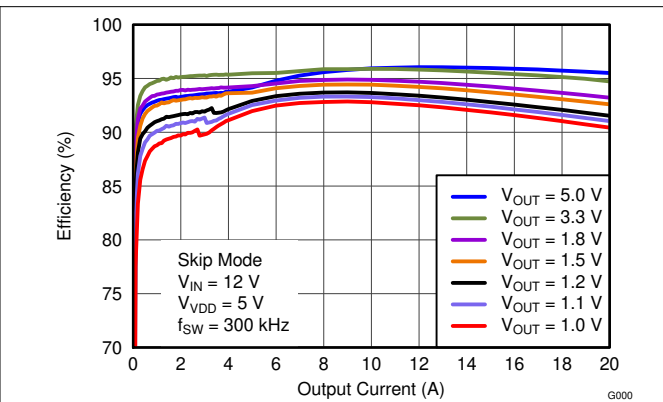

**6-29. Efficiency vs Output Current**

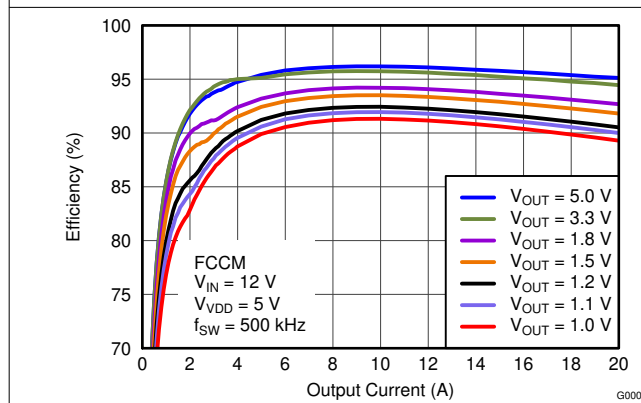

**6-30. Efficiency vs Output Current**

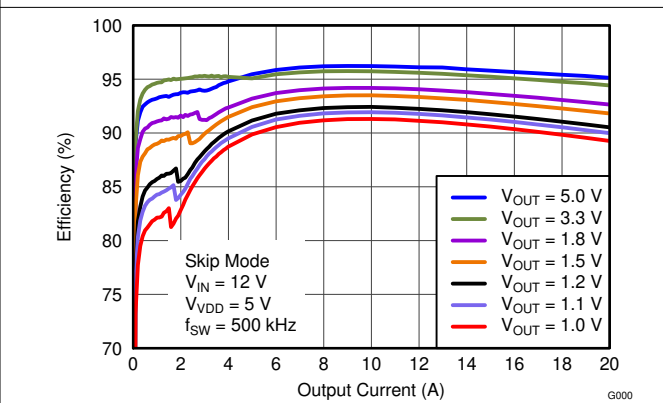

**6-31. Efficiency vs Output Current**

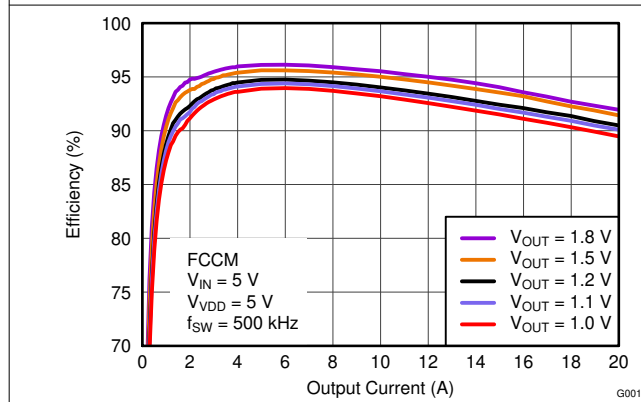

**6-32. Efficiency vs Output Current**

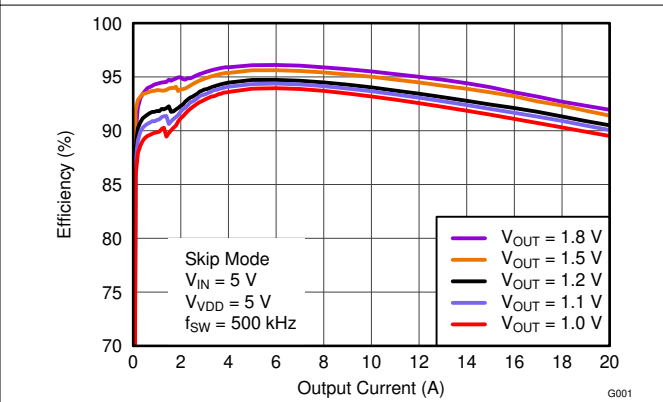

**6-33. Efficiency vs Output Current**

## 7 Detailed Description

### 7.1 Overview

The TPS53353 is a high-efficiency, single channel, synchronous buck converter suitable for low output voltage point-of-load applications in computing and similar digital consumer applications. The device features proprietary D-CAP™ mode control combined with an adaptive on-time architecture. This combination is ideal for building modern low duty ratio, ultra-fast load step response DC-DC converters. The output voltage ranges from 0.6 V to 5.5 V. The conversion input voltage range is from 1.5 V up to 15 V and the VDD bias voltage is from 4.5 V to 25 V. The D-CAP™ mode uses the equivalent series resistance (ESR) of the output capacitor(s) to sense the device current. One advantage of this control scheme is that it does not require an external phase compensation network. This allows a simple design with a low external component count. Eight preset switching frequency values can be chosen using a resistor connected from the RF pin to ground or VREG. Adaptive on-time control tracks the preset switching frequency over a wide input and output voltage range while allowing the switching frequency to increase at the step-up of the load.

The TPS53353 has a MODE pin to select between auto-skip mode and forced continuous conduction mode (FCCM) for light load conditions. The MODE pin also sets the selectable soft-start time ranging from 0.7 ms to 5.6 ms as shown in 表 7-3.

### 7.2 Functional Block Diagram

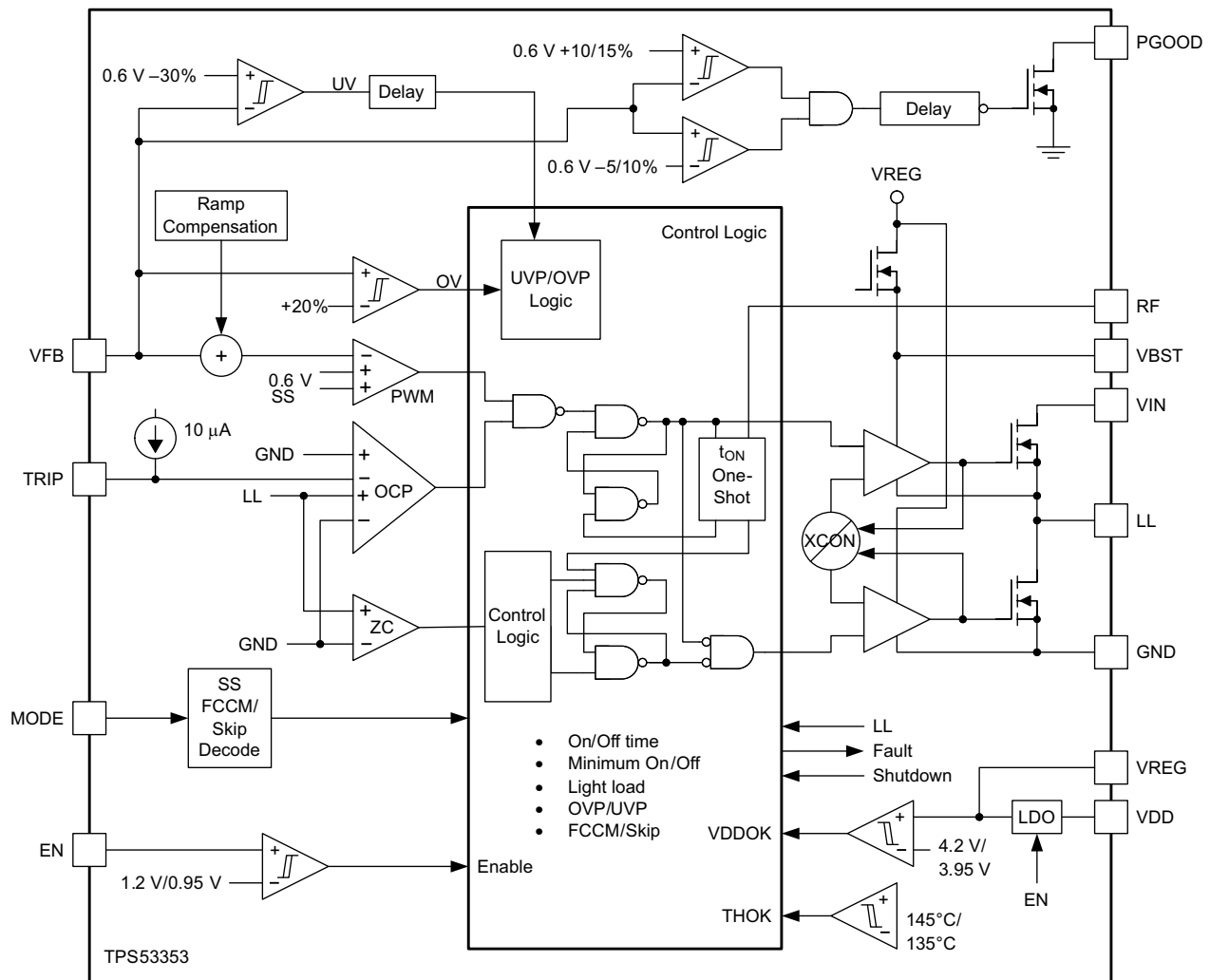

UDG-11048

Copyright © 2016, Texas Instruments Incorporated

### Note

The thresholds in this block diagram are typical values. Refer to the [セクション 6.5](#) table for threshold limits.

## 7.3 Feature Description

### 7.3.1 5-V LDO and VREG Start-Up

TPS53353 provides an internal 5V LDO function using input from VDD and output to VREG. The 5V LDO is gated by the EN pin. The LDO starts-up when EN is approximately 1.8V and VDD is approximately 2V. (See [図 7-1](#)) The LDO outputs its voltage to the VREG pin. The VREG voltage provides the bias voltage for the internal analog circuitry and also provides the supply voltage for the gate drives.

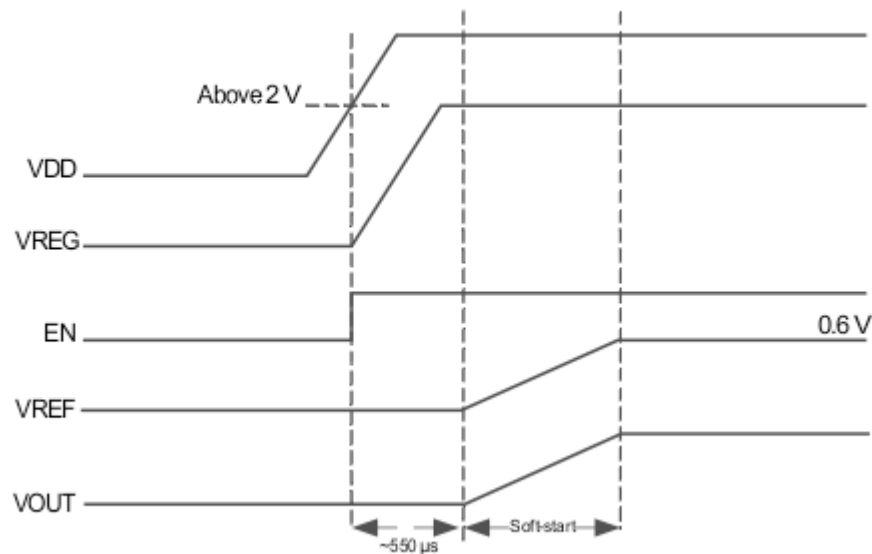

**図 7-1. Power Up Sequence**

### 7.3.2 Adaptive On-Time D-CAP™ Control and Frequency Selection

The TPS53353 does not have a dedicated oscillator to determine switching frequency. However, the device operates with pseudo-constant frequency by feed-forwarding the input and output voltages into the on-time one-shot timer. The adaptive on-time control adjusts the on-time to be inversely proportional to the input voltage and proportional to the output voltage ( $t_{ON} \propto V_{OUT}/V_{IN}$ ).

This makes the switching frequency fairly constant in steady state conditions over a wide input voltage range. The switching frequency is selectable from eight preset values by a resistor connected between the RF pin and GND or between the RF pin and the VREG pin as shown in [表 7-1](#). (Maintaining open resistance sets the switching frequency to 500 kHz.)

**表 7-1. Resistor and Switching Frequency**

RESISTOR ( $R_{RF}$ ) CONNECTIONS		SWITCHING FREQUENCY ( $f_{sw}$ ) (kHz)
VALUE (k $\Omega$ )	CONNECT TO	
0	GND	250
187	GND	300

表 7-1. Resistor and Switching Frequency  
(continued)

RESISTOR ( $R_{RF}$ ) CONNECTIONS		SWITCHING FREQUENCY ( $f_{sw}$ ) (kHz)
VALUE (k $\Omega$ )	CONNECT TO	
619	GND	400
OPEN	n/a	500
866	VREG	650
309	VREG	750
124	VREG	850
0	VREG	970

The off-time is modulated by a PWM comparator. The VFB node voltage (the mid-point of resistor divider) is compared to the internal 0.6-V reference voltage added with a ramp signal. When both signals match, the PWM comparator asserts a set signal to terminate the off time (turn off the low-side MOSFET and turn on high-side MOSFET). The set signal is valid if the inductor current level is below the OCP threshold, otherwise the off time is extended until the current level falls below the threshold.

図 7-2 and 図 7-3 show two on-time control schemes.



图 7-2. On-Time Control Without Ramp Compensation



图 7-3. On-Time Control With Ramp Compensation

### 7.3.3 Ramp Signal

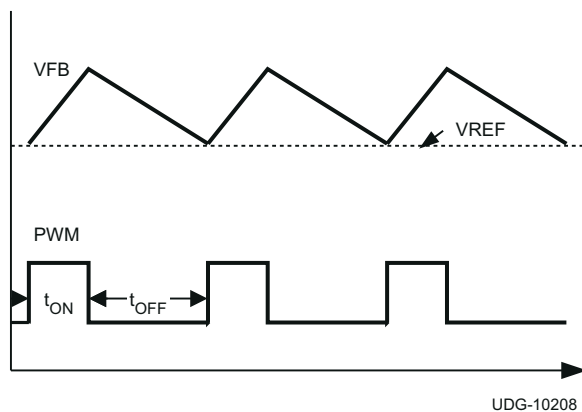
The TPS53353 adds a ramp signal to the 0.6-V reference in order to improve jitter performance. As described in the previous section, the feedback voltage is compared with the reference information to keep the output voltage in regulation. By adding a small ramp signal to the reference, the signal-to-noise ratio at the onset of a new switching cycle is improved. Therefore the operation becomes less jittery and more stable. The ramp signal is controlled to start with  $-7$  mV at the beginning of an on-cycle and becomes 0 mV at the end of an off-cycle in steady state.

During skip mode operation, under discontinuous conduction mode (DCM), the switching frequency is lower than the nominal frequency and the off-time is longer than the off-time in CCM. Because of the longer off-time, the ramp signal extends after crossing 0 mV. However, it is clamped at 3 mV to minimize the DC offset.

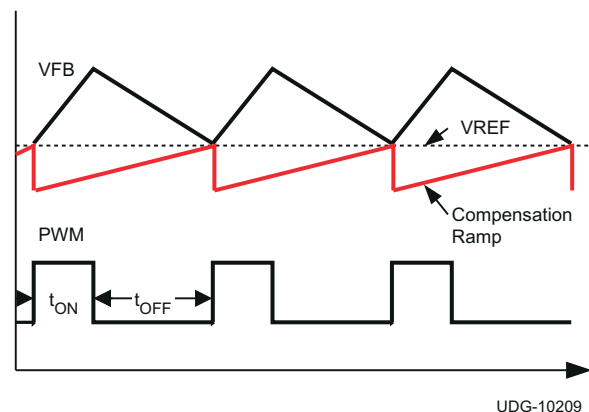
### 7.3.4 Adaptive Zero Crossing

The TPS53353 has an adaptive zero crossing circuit which performs optimization of the zero inductor current detection at skip mode operation. This function pursues ideal low-side MOSFET turning off timing and compensates inherent offset voltage of the Z-C comparator and delay time of the Z-C detection circuit. It

prevents SW-node swing-up caused by too late detection and minimizes diode conduction period caused by too early detection. As a result, better light load efficiency is delivered.

### 7.3.5 Power-Good

The TPS53353 has power-good output that indicates high when switcher output is within the target. The power-good function is activated after soft-start has finished. If the output voltage becomes within +10% and –5% of the target value, internal comparators detect power-good state and the power-good signal becomes high after a 1-ms internal delay. If the output voltage goes outside of +15% or –10% of the target value, the power-good signal becomes low after two microsecond (2- $\mu$ s) internal delay. The power-good output is an open drain output and must be pulled up externally.

The power-good MOSFET is powered through the VDD pin.  $V_{VDD}$  must be >1 V in order to have a valid power-good logic. It is recommended to pull PGOOD up to VREG (or a voltage divided from VREG) so that the power-good logic is still valid even without VDD supply.

### 7.3.6 Current Sense, Overcurrent and Short Circuit Protection

TPS53353 has cycle-by-cycle overcurrent limiting control. The inductor current is monitored during the *OFF* state and the controller maintains the *OFF* state during the period in that the inductor current is larger than the overcurrent trip level. In order to provide both good accuracy and cost effective solution, TPS53353 supports temperature compensated MOSFET  $R_{DS(on)}$  sensing. The TRIP pin should be connected to GND through the trip voltage setting resistor,  $R_{TRIP}$ . The TRIP terminal sources current ( $I_{TRIP}$ ) which is 10  $\mu$ A typically at room temperature, and the trip level is set to the OCL trip voltage  $V_{TRIP}$  as shown in 式 1.

$$V_{TRIP} \text{ (mV)} = R_{TRIP} \text{ (k}\Omega\text{)} \times I_{TRIP} \text{ (}\mu\text{A)} \quad (1)$$

The inductor current is monitored by the LL pin. The GND pin is used as the positive current sensing node and the LL pin is used as the negative current sense node. The trip current,  $I_{TRIP}$  has 4700ppm/ $^{\circ}$ C temperature slope to compensate the temperature dependency of the  $R_{DS(on)}$ .

As the comparison is made during the *OFF* state,  $V_{TRIP}$  sets the valley level of the inductor current. Thus, the load current at the overcurrent threshold,  $I_{OCP}$ , can be calculated as shown in 式 2.

$$I_{OCP} = \frac{V_{TRIP}}{(32 \times R_{DS(on)})} + \frac{I_{IND(ripple)}}{2} = \frac{V_{TRIP}}{(32 \times R_{DS(on)})} + \frac{1}{2 \times L \times f_{SW}} \times \frac{(V_{IN} - V_{OUT}) \times V_{OUT}}{V_{IN}} \quad (2)$$

In an overcurrent or short circuit condition, the current to the load exceeds the current to the output capacitor thus the output voltage tends to decrease. Eventually, it crosses the undervoltage protection threshold and shuts down. After a hiccup delay (16 ms with 0.7 ms sort-start), the controller restarts. If the overcurrent condition remains, the procedure is repeated and the device enters hiccup mode.

Hiccup time calculation:

$$t_{HIC(wait)} = (2^n + 257) \times 4 \mu\text{s} \quad (3)$$

where

- N = 8, 9, 10, or 11 depending on soft start time selection

$$t_{HIC(dly)} = 7 \times (2^n + 257) \times 4 \mu\text{s} \quad (4)$$

**表 7-2. Hiccup Time Calculation**

SELECTED SOFT-START TIME ( $t_{SS}$ ) (ms)	n	HICCUP WAIT TIME ( $t_{HIC(wait)}$ ) (ms)	HICCUP DELAY TIME ( $t_{HIC(dly)}$ ) (ms)
0.7	8	2.052	14.364
1.4	9	3.076	21.532
2.8	10	5.124	35.868



表 7-2. Hiccup Time Calculation (continued)

SELECTED SOFT-START TIME ( $t_{SS}$ ) (ms)	n	HICCUP WAIT TIME ( $t_{HIC(wait)}$ ) (ms)	HICCUP DELAY TIME ( $t_{HIC(dly)}$ ) (ms)
5.6	11	9.22	64.54

### 7.3.7 Overvoltage and Undervoltage Protection

TPS53353 monitors a resistor divided feedback voltage to detect over and under voltage. When the feedback voltage becomes lower than 70% of the target voltage, the UVP comparator output goes high and an internal UVP delay counter begins counting. After 1ms, TPS53353 latches OFF both high-side and low-side MOSFETs drivers. The controller restarts after a hiccup delay (16 ms with 0.7 ms soft-start). This function is enabled 1.5-ms after the soft-start is completed.

When the feedback voltage becomes higher than 120% of the target voltage, the OVP comparator output goes high and the circuit latches OFF the high-side MOSFET driver and latches ON the low-side MOSFET driver. The output voltage decreases. If the output voltage reaches UV threshold, then both high-side MOSFET and low-side MOSFET driver will be OFF and the device restarts after a hiccup delay. If the OV condition remains, both high-side MOSFET and low-side MOSFET driver remains OFF until the OV condition is removed.

### 7.3.8 UVLO Protection

The TPS53353 uses VREG undervoltage lockout protection (UVLO). When the VREG voltage is lower than 3.95 V, the device shuts off. When the VREG voltage is higher than 4.2V, the device restarts. This is a non-latch protection.

### 7.3.9 Thermal Shutdown

TPS53353 monitors the temperature of itself. If the temperature exceeds the threshold value (typically 145°C), TPS53353 is shut off. When the temperature falls about 10°C below the threshold value, the device will turn back on. This is a non-latch protection.

## 7.4 Device Functional Modes

### 7.4.1 Small Signal Model

From small-signal loop analysis, a buck converter using D-CAP™ mode can be simplified as shown in [Figure 7-4](#).



图 7-4. Simplified Modulator Model

The output voltage is compared with the internal reference voltage (ramp signal is ignored here for simplicity). The PWM comparator determines the timing to turn on the high-side MOSFET. The gain and speed of the

comparator can be assumed high enough to keep the voltage at the beginning of each on cycle substantially constant.

$$H(s) = \frac{1}{s \times \text{ESR} \times C_{\text{OUT}}} \quad (5)$$

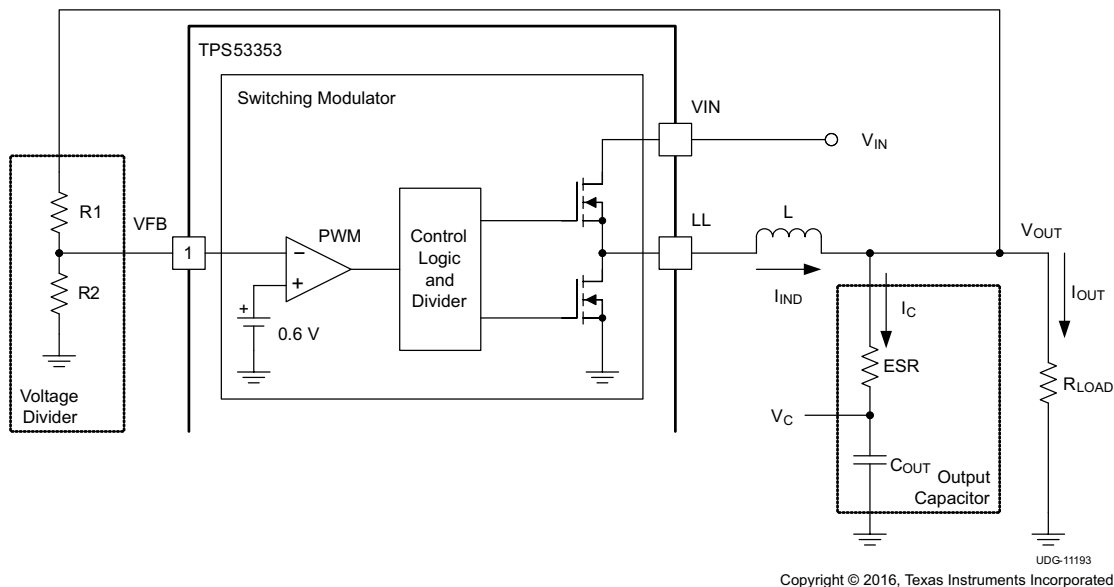
For loop stability, the 0-dB frequency,  $f_0$ , defined in 式 6 needs to be lower than 1/4 of the switching frequency.

$$f_0 = \frac{1}{2\pi \times \text{ESR} \times C_{\text{OUT}}} \leq \frac{f_{\text{SW}}}{4} \quad (6)$$

According to 式 6, the loop stability of D-CAP™ mode modulator is mainly determined by the capacitor's chemistry. For example, specialty polymer capacitors (SP-CAP) have an output capacitance in the order of several 100  $\mu\text{F}$  and ESR in range of 10 m $\Omega$ . These makes  $f_0$  on the order of 100 kHz or less, creating a stable loop. However, ceramic capacitors have an  $f_0$  at more than 700 kHz, and need special care when used with this modulator. An application circuit for ceramic capacitor is described in セクション 8.2.2.2.2.

### 7.4.2 Enable, Soft Start, and Mode Selection

When the EN pin voltage rises above the enable threshold voltage (typically 1.2 V), the controller enters its start-up sequence. The internal LDO regulator starts immediately and regulates to 5 V at the VREG pin. The controller then uses the first 250  $\mu\text{s}$  to calibrate the switching frequency setting resistance attached to the RF pin and stores the switching frequency code in internal registers. During this period, the MODE pin also senses the resistance attached to this pin and determines the soft-start time. Switching is inhibited during this phase. In the second phase, an internal DAC starts ramping up the reference voltage from 0 V to 0.6 V. Depending on the MODE pin setting, the ramping up time varies from 0.7 ms to 5.6 ms. Smooth and constant ramp-up of the output voltage is maintained during start-up regardless of load current.

**表 7-3. Soft-Start and MODE Settings**

MODE SELECTION	ACTION	SOFT-START TIME (ms)	R <sub>MODE</sub> (k $\Omega$ )
Auto-skip	Pulldown to GND	0.7	39
		1.4	100
		2.8	200
		5.6	475
Forced CCM <sup>(1)</sup>	Connect to PGOOD	0.7	39
		1.4	100
		2.8	200
		5.6	475

(1) Device enters FCCM after the PGOOD pin goes high when MODE is connected to PGOOD through the resistor R<sub>MODE</sub>.

After soft-start begins, the MODE pin becomes the input of an internal comparator which determines auto-skip or FCCM mode operation. If MODE voltage is higher than 1.3 V, the converter enters into FCCM mode. Otherwise it will be in auto-skip mode at light load condition. Typically, when FCCM mode is selected, the MODE pin is connected to PGOOD through the R<sub>MODE</sub> resistor, so that before PGOOD goes high the converter remains in auto-skip mode.

### 7.4.3 Auto-Skip Eco-mode™ Light Load Operation

While the MODE pin is pulled low via R<sub>MODE</sub>, TPS53353 automatically reduces the switching frequency at light load conditions to maintain high efficiency. Detailed operation is described as follows. As the output current decreases from heavy load condition, the inductor current is also reduced and eventually comes to the point that its rippled valley touches zero level, which is the boundary between continuous conduction and discontinuous conduction modes. The synchronous MOSFET is turned off when this zero inductor current is detected. As the load current further decreases, the converter runs into discontinuous conduction mode (DCM). The on-time is

kept almost the same as it was in the continuous conduction mode so that it takes longer to discharge the output capacitor with smaller load current to the level of the reference voltage. The transition point to the light-load operation  $I_{OUT(LL)}$  (that is, the threshold between continuous and discontinuous conduction mode) can be calculated as shown in 式 7.

$$I_{OUT(LL)} = \frac{1}{2 \times L \times f_{SW}} \times \frac{(V_{IN} - V_{OUT}) \times V_{OUT}}{V_{IN}} \quad (7)$$

where

- $f_{SW}$  is the PWM switching frequency

Switching frequency versus output current in the light load condition is a function of  $L$ ,  $V_{IN}$ , and  $V_{OUT}$ , but it decreases almost proportionally to the output current from the  $I_{OUT(LL)}$  given in 式 7. For example, it is 60 kHz at  $I_{OUT(LL)}/5$  if the frequency setting is 300 kHz.

#### 7.4.4 Forced Continuous Conduction Mode

When the MODE pin is tied to PGOOD through a resistor, the controller keeps continuous conduction mode (CCM) in light load condition. In this mode, switching frequency is kept almost constant over the entire load range which is suitable for applications need tight control of the switching frequency at a cost of lower efficiency.

## 8 Application and Implementation

### Note

Information in the following applications sections is not part of the TI component specification, and TI does not warrant its accuracy or completeness. TI's customers are responsible for determining suitability of components for their purposes, as well as validating and testing their design implementation to confirm system functionality.

### 8.1 Application Information

The TPS53353 is a high-efficiency, single channel, synchronous buck converter suitable for low output voltage point-of-load applications in computing and similar digital consumer applications. The device features proprietary D-CAP mode control combined with an adaptive on-time architecture. This combination is ideal for building modern low duty ratio, ultra-fast load step response DC-DC converters. The output voltage ranges from 0.6 V to 5.5 V. The conversion input voltage range is from 1.5 V up to 15 V and the VDD bias voltage is from 4.5 V to 25 V. The D-CAP mode uses the equivalent series resistance (ESR) of the output capacitor(s) to sense the device current. One advantage of this control scheme is that it does not require an external phase compensation network. This allows a simple design with a low external component count. Eight preset switching frequency values can be chosen using a resistor connected from the RF pin to ground or VREG. Adaptive on-time control tracks the preset switching frequency over a wide input and output voltage range while allowing the switching frequency to increase at the step-up of the load.

### 8.2 Typical Applications

#### 8.2.1 Typical Application Circuit Diagram

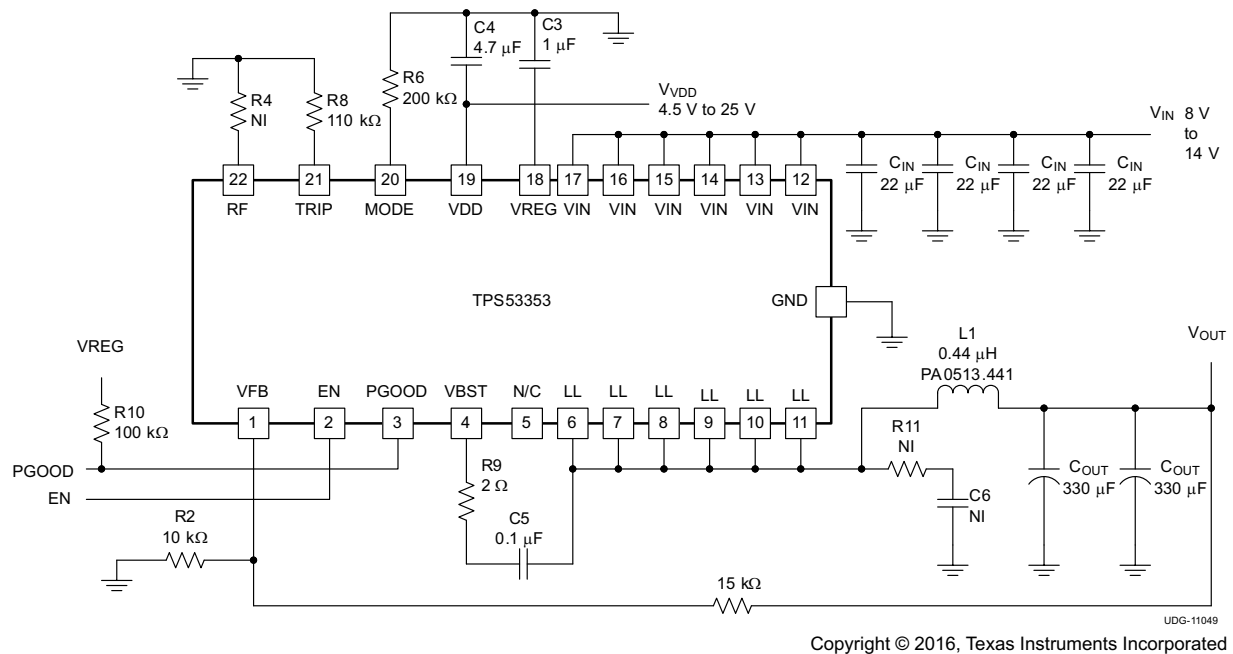

**8-1. Typical Application Circuit Diagram**

### 8.2.1.1 Design Requirements

**表 8-1. Design Parameters**

PARAMETER		TEST CONDITIONS	MIN	TYP	MAX	UNIT
<b>INPUT CHARACTERISTICS</b>						
V <sub>IN</sub>	Voltage range		8	12	14	V
I <sub>MAX</sub>	Maximum Input current	V <sub>IN</sub> = 8 V, I <sub>OUT</sub> = 20 A		4.1		A
	No load input current	V <sub>IN</sub> = 14 V, I <sub>OUT</sub> = 0 A with auto-skip mode		1		mA
<b>OUTPUT CHARACTERISTICS</b>						
V <sub>OUT</sub>	Output voltage			1.5		V
	Output voltage regulation	Line regulation, 8 V ≤ V <sub>IN</sub> ≤ 15 V		0.1%		
		Load regulation, V <sub>IN</sub> = 12 V, 0 A ≤ I <sub>OUT</sub> ≤ 20 A with FCCM			0.2%	
V <sub>RIPPLE</sub>	Output voltage ripple	V <sub>IN</sub> = 12 V, I <sub>OUT</sub> = 20 A with FCCM		20		mV <sub>PP</sub>
I <sub>LOAD</sub>	Output load current		0		20	A
I <sub>OCP</sub>	Output overcurrent threshold			26		A
t <sub>SS</sub>	Soft-start time			1.4		ms
<b>SYSTEMS CHARACTERISTICS</b>						
f <sub>SW</sub>	Switching frequency			500		kHz
η	Peak efficiency	V <sub>IN</sub> = 12 V, V <sub>OUT</sub> = 1.1 V, I <sub>OUT</sub> = 10 A		91.87%		
	Full load efficiency	V <sub>IN</sub> = 12 V, V <sub>OUT</sub> = 1.1 V, I <sub>OUT</sub> = 20 A		91.38%		
T <sub>A</sub>	Operating temperature			25		°C

### 8.2.1.2 Detailed Design Procedure

#### 8.2.1.2.1 External Component Selection

Refer to [セクション 8.2.2.2](#) for guidelines for this design with all ceramic output capacitors.

The external components selection is a simple process when using organic semiconductors or special polymer output capacitors.

#### 1. SELECT OPERATION MODE AND SOFT-START TIME

Select operation mode and soft-start time using [表 7-3](#).

#### 2. SELECT SWITCHING FREQUENCY

Select the switching frequency from 250 kHz to 1 MHz using [表 7-1](#).

#### 3. CHOOSE THE INDUCTOR

The inductance value should be determined to give the ripple current of approximately 1/4 to 1/2 of maximum output current. Larger ripple current increases output ripple voltage and improves signal-to-noise ratio and helps ensure stable operation, but increases inductor core loss. Using 1/3 ripple current to maximum output current ratio, the inductance can be determined by [式 8](#).

$$L = \frac{1}{I_{IND(ripple)} \times f_{SW}} \times \frac{(V_{IN(max)} - V_{OUT}) \times V_{OUT}}{V_{IN(max)}} = \frac{3}{I_{OUT(max)} \times f_{SW}} \times \frac{(V_{IN(max)} - V_{OUT}) \times V_{OUT}}{V_{IN(max)}} \quad (8)$$

The inductor requires a low DCR to achieve good efficiency. It also requires enough room above peak inductor current before saturation. The peak inductor current can be estimated in [式 9](#).

$$I_{\text{IND(peak)}} = \frac{V_{\text{TRIP}}}{32 \times R_{\text{DS(on)}}} + \frac{1}{L \times f_{\text{SW}}} \times \frac{(V_{\text{IN(max)}} - V_{\text{OUT}}) \times V_{\text{OUT}}}{V_{\text{IN(max)}}} \quad (9)$$

#### 4. CHOOSE THE OUTPUT CAPACITORS

When organic semiconductor capacitors or specialty polymer capacitors are used, for loop stability, capacitance and ESR should satisfy 式 6. For jitter performance, 式 10 is a good starting point to determine ESR.

$$\text{ESR} = \frac{V_{\text{OUT}} \times 10\text{mV} \times (1-D)}{0.6\text{V} \times I_{\text{IND(ripple)}}} = \frac{10\text{mV} \times L \times f_{\text{SW}}}{0.6\text{V}} = \frac{L \times f_{\text{SW}}}{60} (\Omega) \quad (10)$$

where

- D is the duty factor.
- The required output ripple slope is approximately 10 mV per  $t_{\text{SW}}$  (switching period) in terms of VFB terminal voltage.

#### 5. DETERMINE THE VALUE OF R1 AND R2

The output voltage is programmed by the voltage-divider resistor, R1 and R2 shown in 图 7-4. R1 is connected between VFB pin and the output, and R2 is connected between the VFB pin and GND. Recommended R2 value is from 1 kΩ to 20 kΩ. Determine R1 using 式 11.

$$R1 = \frac{V_{\text{OUT}} - \frac{I_{\text{IND(ripple)}} \times \text{ESR}}{2} - 0.6}{0.6} \times R2 \quad (11)$$

#### 6. CHOOSE THE OVERCURRENT SETTING RESISTOR

The overcurrent setting resistor,  $R_{\text{TRIP}}$ , can be determined by 式 12 .

$$R_{\text{TRIP}}(\text{k}\Omega) = \frac{\left( I_{\text{OCP}} - \left( \frac{1}{2 \times L \times f_{\text{SW}}} \right) \times \frac{(V_{\text{IN}} - V_{\text{OUT}}) \times V_{\text{OUT}}}{V_{\text{IN}}} \right) \times 32 \times R_{\text{DS(on)}}(\text{m}\Omega)}{I_{\text{TRIP}}(\mu\text{A})} \quad (12)$$

where

- $I_{\text{TRIP}}$  is the TRIP pin sourcing current (10  $\mu\text{A}$ ).
- $R_{\text{DS(on)}}$  is the thermally compensated on-time resistance value of the low-side MOSFET.

Use an  $R_{\text{DS(on)}}$  value of 1.6 mΩ for an overcurrent level of approximately 20 A. Use an  $R_{\text{DS(on)}}$  value of 1.7 mΩ for overcurrent level of approximately 10 A.

### 8.2.1.3 Application Curves

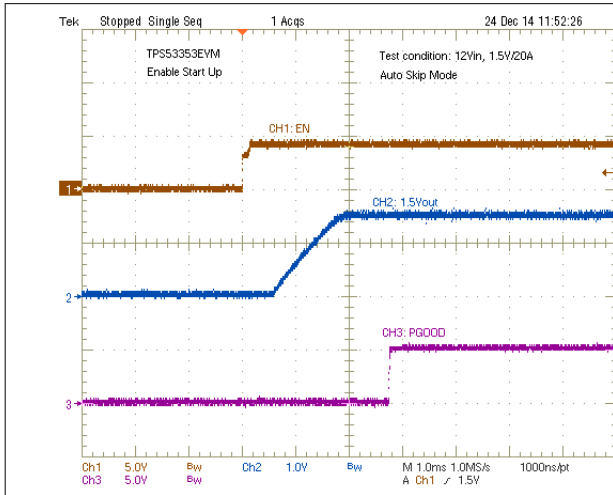

8-2. Enable Turnon

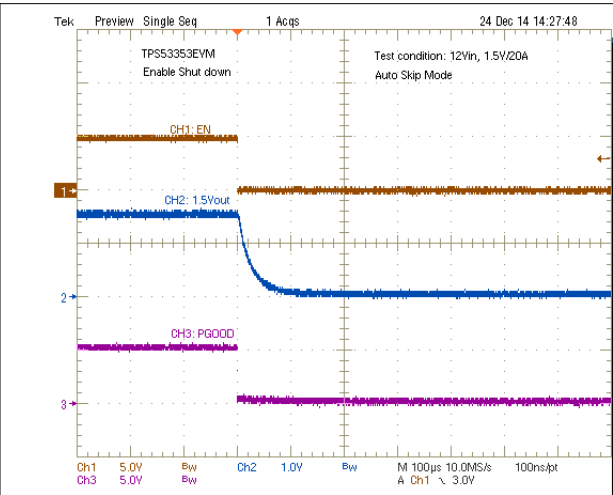

8-3. Enable Turnoff

### 8.2.2 Typical Application Circuit Diagram With Ceramic Output Capacitors

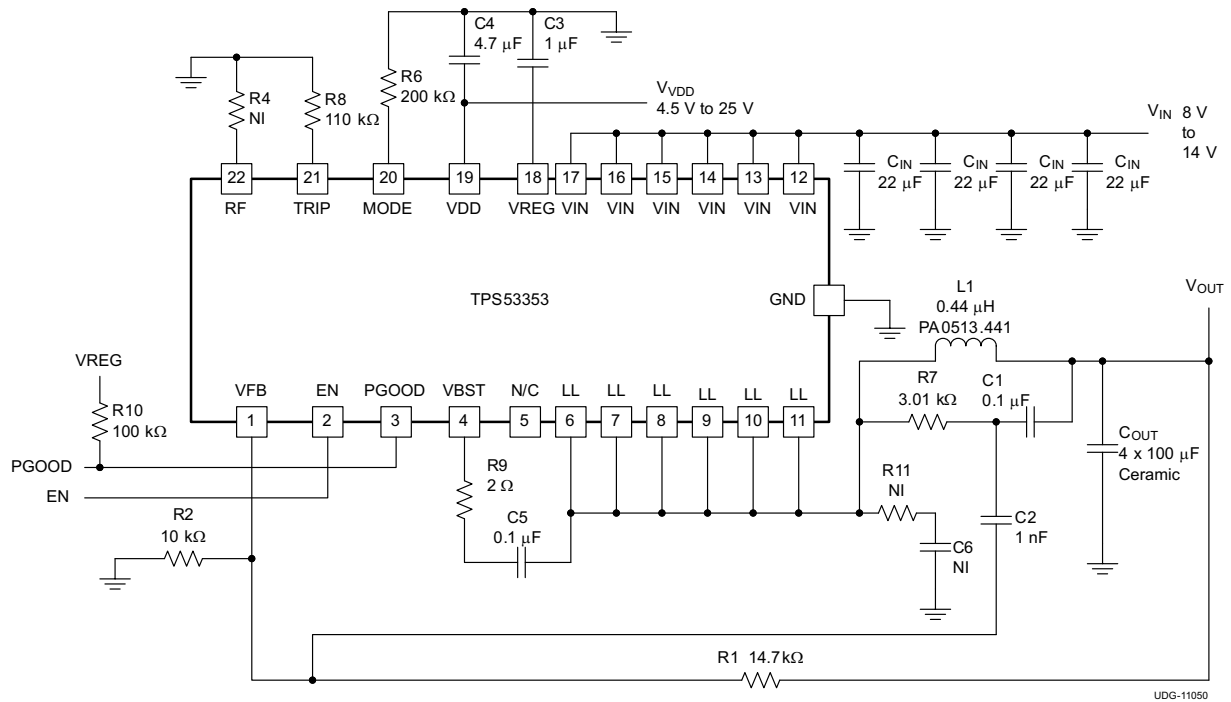

8-4. Typical Application Circuit Diagram With Ceramic Output Capacitors

### 8.2.2.1 Design Requirements

表 8-2. Design Parameters

PARAMETER		TEST CONDITIONS	MIN	TYP	MAX	UNIT
<b>INPUT CHARACTERISTICS</b>						
$V_{IN}$	Voltage range		8	12	14	V
$I_{MAX}$	Maximum Input current	$V_{IN} = 8\text{ V}, I_{OUT} = 20\text{ A}$		4.1		A
	No load input current	$V_{IN} = 14\text{ V}, I_{OUT} = 0\text{ A}$ with auto-skip mode		1		mA
<b>OUTPUT CHARACTERISTICS</b>						
$V_{OUT}$	Output voltage			1.5		V
	Output voltage regulation	Line regulation, $8\text{ V} \leq V_{IN} \leq 15\text{ V}$		0.1%		
		Load regulation, $V_{IN} = 12\text{ V}, 0\text{ A} \leq I_{OUT} \leq 20\text{ A}$ with FCCM			0.2%	
$V_{RIPPLE}$	Output voltage ripple	$V_{IN} = 12\text{ V}, I_{OUT} = 20\text{ A}$ with FCCM		20		mV <sub>PP</sub>
$I_{LOAD}$	Output load current		0		20	A
$I_{OCP}$	Output overcurrent threshold			26		A
$t_{SS}$	Soft-start time			1.4		ms
<b>SYSTEMS CHARACTERISTICS</b>						
$f_{SW}$	Switching frequency			500		kHz
$\eta$	Peak efficiency	$V_{IN} = 12\text{ V}, V_{OUT} = 1.1\text{ V}, I_{OUT} = 10\text{ A}$		91.87%		
	Full load efficiency	$V_{IN} = 12\text{ V}, V_{OUT} = 1.1\text{ V}, I_{OUT} = 20\text{ A}$		91.38%		
$T_A$	Operating temperature			25		°C

### 8.2.2.2 Detailed Design Procedure

#### 8.2.2.2.1 External Component Selection

Refer to [セクション 8.2.2.2.2](#) for guidelines for this design with all ceramic output capacitors.

The external components selection is a simple process when using organic semiconductors or special polymer output capacitors.

#### 1. Select Operation Mode and Soft-Start Time

Select operation mode and soft-start time using [表 7-3](#).

#### 2. Select Switching Frequency

Select the switching frequency from 250 kHz to 1 MHz using [表 7-1](#).

#### 3. Choose The Inductor

The inductance value should be determined to give the ripple current of approximately 1/4 to 1/2 of maximum output current. Larger ripple current increases output ripple voltage and improves signal-to-noise ratio and helps ensure stable operation, but increases inductor core loss. Using 1/3 ripple current to maximum output current ratio, the inductance can be determined by [式 8](#).

$$L = \frac{1}{I_{IND(ripple)} \times f_{SW}} \times \frac{(V_{IN(max)} - V_{OUT}) \times V_{OUT}}{V_{IN(max)}} = \frac{3}{I_{OUT(max)} \times f_{SW}} \times \frac{(V_{IN(max)} - V_{OUT}) \times V_{OUT}}{V_{IN(max)}} \quad (13)$$

The inductor requires a low DCR to achieve good efficiency. It also requires enough room above peak inductor current before saturation. The peak inductor current can be estimated in [式 9](#).



$$I_{\text{IND(peak)}} = \frac{V_{\text{TRIP}}}{32 \times R_{\text{DS(on)}}} + \frac{1}{L \times f_{\text{SW}}} \times \frac{(V_{\text{IN(max)}} - V_{\text{OUT}}) \times V_{\text{OUT}}}{V_{\text{IN(max)}}} \quad (14)$$

#### 4. External Component Selection with All Ceramic Output Capacitors

Refer to [セクション 8.2.2.2.2](#) to select external components because ceramic output capacitors are used in this design.

#### 5. Choose the Overcurrent Setting Resistor

The overcurrent setting resistor,  $R_{\text{TRIP}}$ , can be determined by [式 15](#).

$$R_{\text{TRIP}}(\text{k}\Omega) = \frac{\left( I_{\text{OCP}} - \left( \frac{1}{2 \times L \times f_{\text{SW}}} \right) \times \frac{(V_{\text{IN}} - V_{\text{OUT}}) \times V_{\text{OUT}}}{V_{\text{IN}}} \right) \times 32 \times R_{\text{DS(on)}}(\text{m}\Omega)}{I_{\text{TRIP}}(\mu\text{A})} \quad (15)$$

where

- $I_{\text{TRIP}}$  is the TRIP pin sourcing current (10  $\mu\text{A}$ ).
- $R_{\text{DS(on)}}$  is the thermally compensated on-time resistance value of the low-side MOSFET.

Use an  $R_{\text{DS(on)}}$  value of 1.6 m $\Omega$  for an overcurrent level of approximately 20 A. Use an  $R_{\text{DS(on)}}$  value of 1.7 m $\Omega$  for overcurrent level of approximately 10 A.

#### 6. BST Resistor Selection

The recommended BST resistor value is 2  $\Omega$  and anything larger than 5.1  $\Omega$  is not recommended. Note that when the gate drive turns on, the voltage on the boot-strap capacitor splits between the internal pull-up resistance and the boot-strap resistance, with the internal circuits only seeing the portion across the internal pull-up resistance. Therefore, when the external resistor gets larger than the pull-up resistance, it crashes the head-room of the SW to BOOT logic, which can cause logic issues with the high-side gate driver.

##### 8.2.2.2.2 External Component Selection Using All Ceramic Output Capacitors

When a ceramic output capacitor is used, the stability criteria in [式 6](#) cannot be satisfied. The ripple injection approach as shown in [図 8-4](#) is implemented to increase the ripple on the VFB pin and make the system stable. In addition to the selections made using Steps 1 through Step 5 in [セクション 8.2.2.1](#), the ripple injection components must be selected. The C2 value can be fixed at 1 nF. The value of C1 can be selected from 10 nF to 200 nF.

$$\frac{L \times C_{\text{OUT}}}{R7 \times C1} > N \times \frac{t_{\text{ON}}}{2} \quad (16)$$

where

- N is the coefficient to account for L and  $C_{\text{OUT}}$  variation.

N is also used to provide enough margin for stability. It is recommended  $N = 2$  for  $V_{\text{OUT}} \leq 1.8 \text{ V}$  and  $N = 4$  for  $V_{\text{OUT}} \geq 3.3 \text{ V}$  or when  $L \leq 250 \text{ nH}$ . The higher  $V_{\text{OUT}}$  needs a higher N value because the effective output capacitance is reduced significantly with higher DC bias. For example, a 6.3-V, 22- $\mu\text{F}$  ceramic capacitor may have only 8  $\mu\text{F}$  of effective capacitance when biased at 5 V.

Because the VFB pin voltage is regulated at the valley, the increased ripple on the VFB pin causes the increase of the VFB DC value. The AC ripple coupled to the VFB pin has two components, one coupled from SW node and the other coupled from the VOUT pin and they can be calculated using [式 17](#) and [式 18](#) when neglecting the output voltage ripple caused by equivalent series inductance (ESL).

$$V_{INJ\_SW} = \frac{V_{IN} - V_{OUT}}{R7 \times C1} \times \frac{D}{f_{SW}} \quad (17)$$

$$V_{INJ\_OUT} = ESR \times I_{IND(ripple)} + \frac{I_{IND(ripple)}}{8 \times C_{OUT} \times f_{SW}} \quad (18)$$

It is recommended that  $V_{INJ\_SW}$  to be less than 50 mV and  $V_{INJ\_TOTAL}$  to be less than 60mV. If the calculated  $V_{INJ\_SW}$  is higher than 50 mV, then other parameters must be adjusted to reduce it. For example,  $C_{OUT}$  can be increased to satisfy 式 16 with a higher R7 value, thereby reducing  $V_{INJ\_SW}$ . Use 式 19 to calculate  $C_{OUT}$  capacitance needed. For a more holistic calculation, please reference the TPS53353 calculator on ti.com

$$C_{OUT} = \frac{V_{IN(MAX)} - V_{OUT}}{2 \times L \times V_{INJ(MAX)}} \times N \times t_{ON} \quad (19)$$

The DC voltage at the VFB pin can be calculated by 式 20:

$$V_{VFB} = 0.6 + \frac{V_{INJ\_SW} + V_{INJ\_OUT}}{2} \quad (20)$$

And the resistor divider value can be determined by 式 21:

$$R1 = \frac{V_{OUT} - V_{VFB}}{V_{VFB}} \times R2 \quad (21)$$

### 8.2.2.3 Application Curves

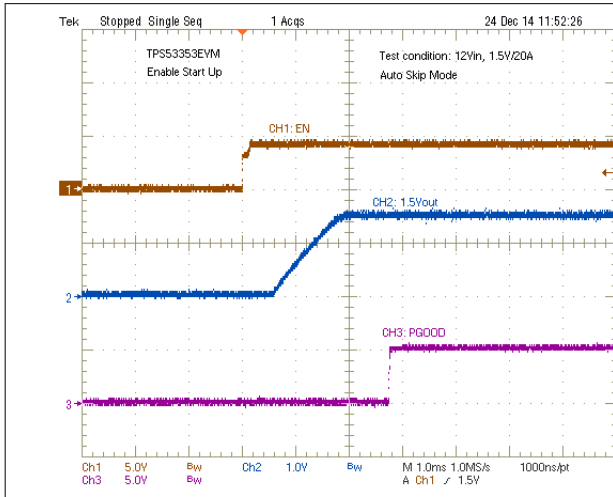

**8-5. Enable Turnon**

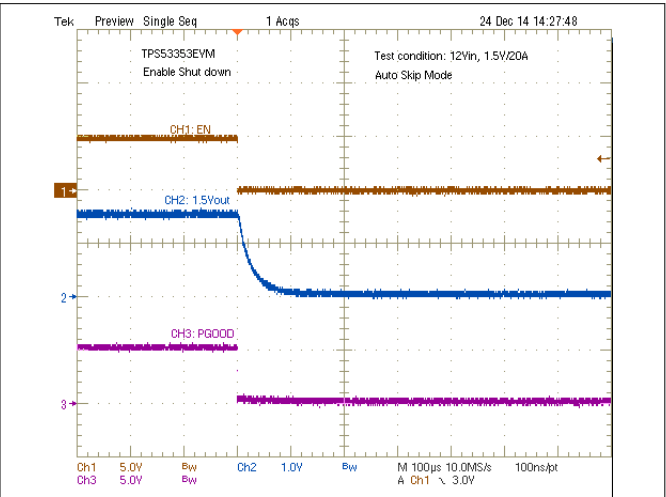

**8-6. Enable Turnoff**

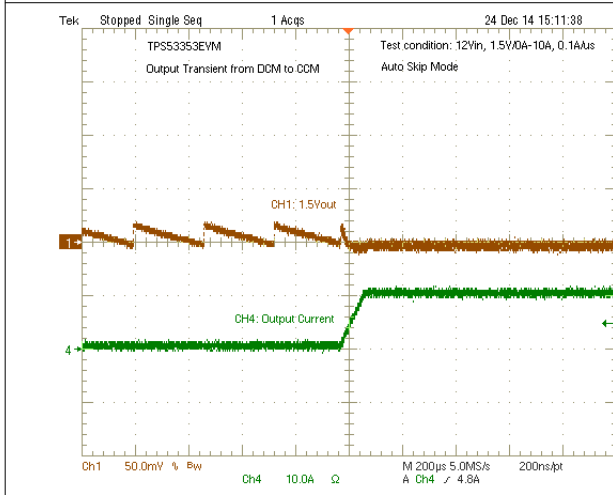

**8-7. Output Transient from DCM to CCM**

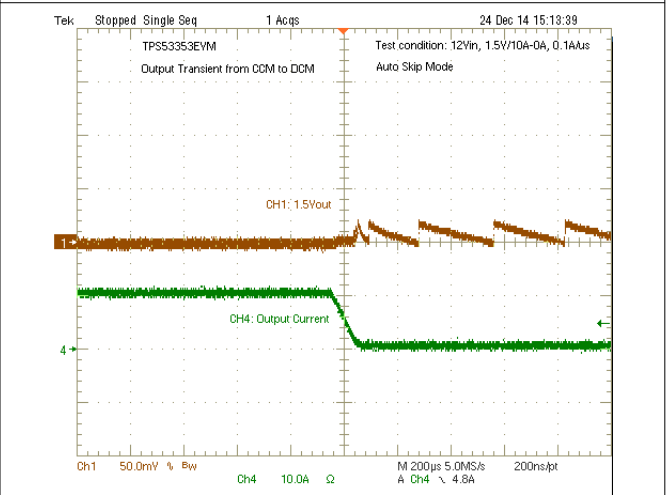

**8-8. Output Transient from DCM to DCM**

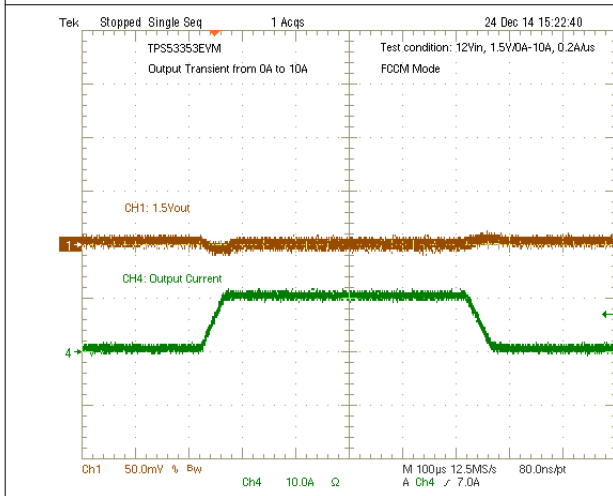

**8-9. Output Transient with FCCM Mode**

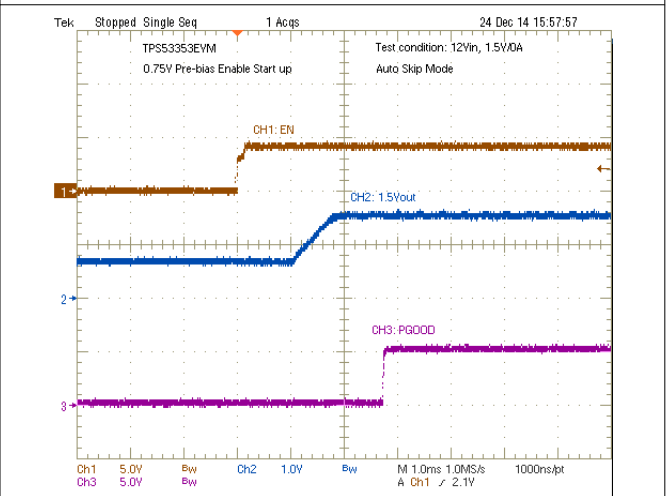

**8-10. Output 0.75-V Prebias Turnon**

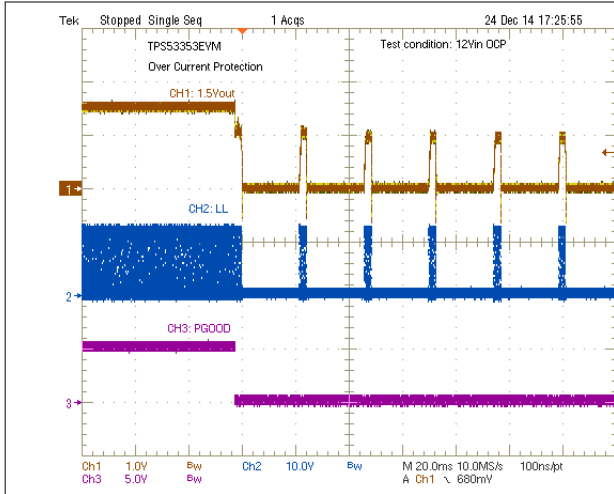

**图 8-11. Output Overcurrent Protection**

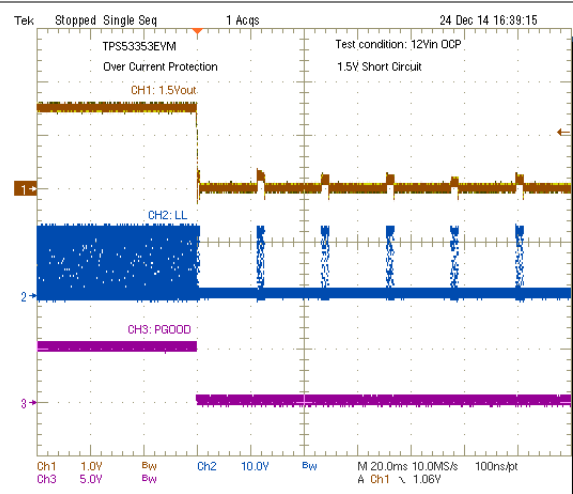

**图 8-12. Output Short-Circuit Protection**

## 9 Power Supply Recommendations

The device is designed to operate from an input voltage supply range from 1.5 V to 22 V (4.5 V to 25 V biased). This input supply must be well regulated. Proper bypassing of input supplies and internal regulators is also critical for noise performance, as is PCB layout and grounding scheme. See the recommendations in [セクション 10](#).

## 10 Layout

### 10.1 Layout Guidelines

Certain points must be considered before starting a layout work using the TPS53353.

- The power components (including input/output capacitors, inductor and TPS53353) should be placed on one side of the PCB (solder side). At least one inner plane should be inserted, connected to ground, in order to shield and isolate the small signal traces from noisy power lines.
- All sensitive analog traces and components such as VFB, PGOOD, TRIP, MODE and RF should be placed away from high-voltage switching nodes such as LL, VBST to avoid coupling. Use internal layer(s) as ground plane(s) and shield feedback trace from power traces and components.
- Place the VIN decoupling capacitors as close to the VIN and PGND pins as possible to minimize the input AC current loop.
- Because the TPS53353 controls output voltage referring to voltage across VOUT capacitor, the top-side resistor of the voltage divider should be connected to the positive node of the VOUT capacitor. The GND of the bottom side resistor should be connected to the GND pad of the device. The trace from these resistors to the VFB pin should be short and thin.
- Place the frequency setting resistor ( $R_F$ ), OCP setting resistor ( $R_{TRIP}$ ) and mode setting resistor ( $R_{MODE}$ ) as close to the device as possible. Use the common GND via to connect them to GND plane if applicable.
- Place the VDD and VREG decoupling capacitors as close to the device as possible. Ensure to provide GND vias for each decoupling capacitor and make the loop as small as possible.
- The PCB trace defined as switch node, which connects the LL pins and high-voltage side of the inductor, should be as short and wide as possible.
- Connect the ripple injection  $V_{OUT}$  signal ( $V_{OUT}$  side of the C1 capacitor in [Figure 8-4](#)) from the terminal of ceramic output capacitor. The AC coupling capacitor (C2 in [Figure 8-4](#)) should be placed near the device, and R7 and C1 can be placed near the power stage.
- Use separated vias or trace to connect LL node to snubber, boot strap capacitor and ripple injection resistor. Do not combine these connections.

## 10.2 Layout Example

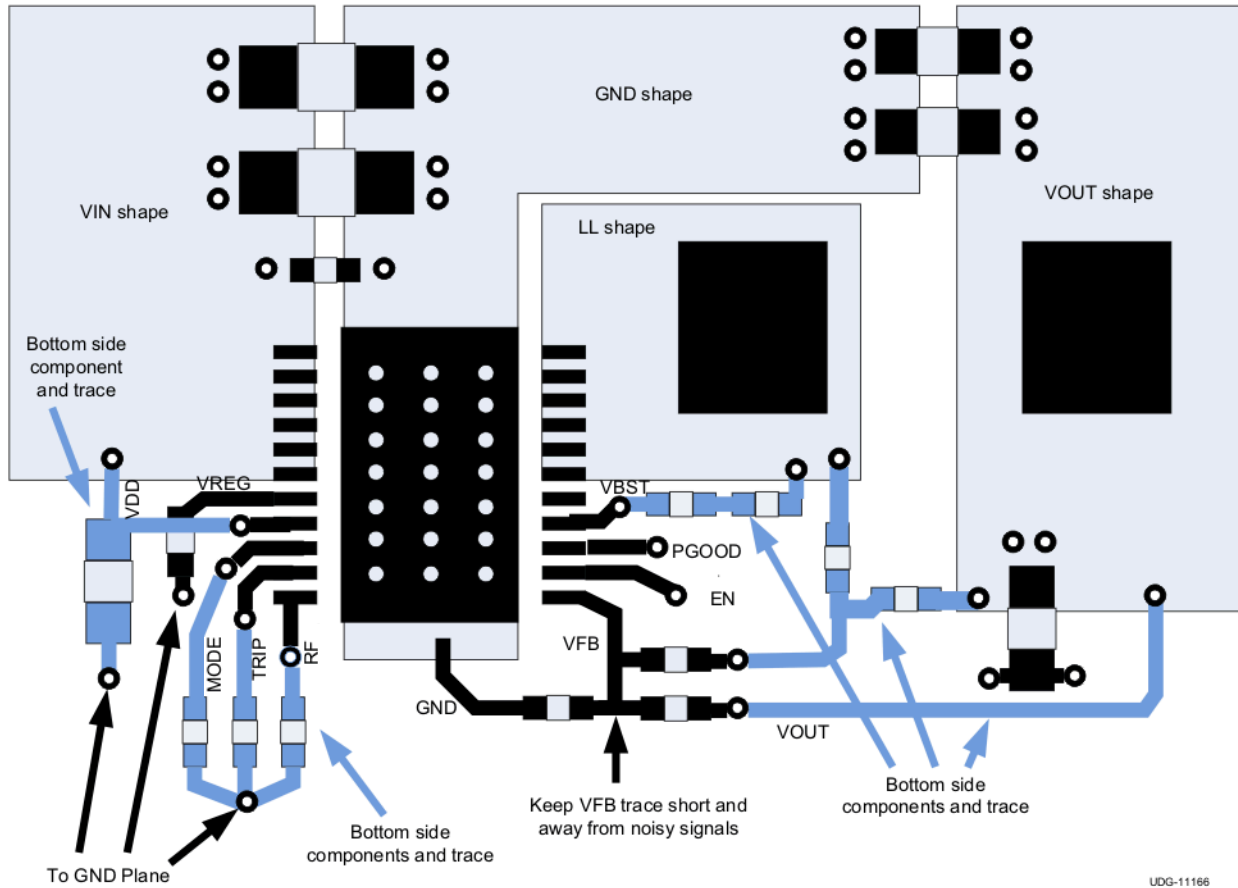

UDG-11166

☒ 10-1. Layout Recommendation

## 11 Device and Documentation Support

### 11.1 Device Support

#### 11.1.1 Third-Party Products Disclaimer

TI'S PUBLICATION OF INFORMATION REGARDING THIRD-PARTY PRODUCTS OR SERVICES DOES NOT CONSTITUTE AN ENDORSEMENT REGARDING THE SUITABILITY OF SUCH PRODUCTS OR SERVICES OR A WARRANTY, REPRESENTATION OR ENDORSEMENT OF SUCH PRODUCTS OR SERVICES, EITHER ALONE OR IN COMBINATION WITH ANY TI PRODUCT OR SERVICE.

#### 11.2 Receiving Notification of Documentation Updates

To receive notification of documentation updates, navigate to the device product folder on [ti.com](http://ti.com). Click on *Subscribe to updates* to register and receive a weekly digest of any product information that has changed. For change details, review the revision history included in any revised document.

#### 11.3 サポート・リソース

[TI E2E™ サポート・フォーラム](#)は、エンジニアが検証済みの回答と設計に関するヒントをエキスパートから迅速かつ直接得ることができる場所です。既存の回答を検索したり、独自の質問をしたりすることで、設計に必要な支援を迅速に得ることができます。

リンクされているコンテンツは、該当する貢献者により、現状のまま提供されるものです。これらは TI の仕様を構成するものではなく、必ずしも TI の見解を反映したものではありません。TI の[使用条件](#)を参照してください。

#### 11.4 Trademarks

Eco-mode™, NexFET™, and PowerPAD™ are trademarks of TI.

SWIFT™ and TI E2E™ are trademarks of Texas Instruments.

すべての商標は、それぞれの所有者に帰属します。

#### 11.5 静電気放電に関する注意事項



この IC は、ESD によって破損する可能性があります。テキサス・インスツルメンツは、IC を取り扱う際には常に適切な注意を払うことを推奨します。正しい ESD 対策をとらないと、デバイスを破損するおそれがあります。

ESD による破損は、わずかな性能低下からデバイスの完全な故障まで多岐にわたります。精密な IC の場合、パラメータがわずかに変化するだけで公表されている仕様から外れる可能性があるため、破損が発生しやすくなっています。

#### 11.6 用語集

[TI 用語集](#) この用語集には、用語や略語の一覧および定義が記載されています。

### Mechanical, Packaging, and Orderable Information

The following pages include mechanical, packaging, and orderable information. This information is the most current data available for the designated devices. This data is subject to change without notice and revision of this document. For browser-based versions of this data sheet, refer to the left-hand navigation.



**PACKAGING INFORMATION**

Orderable part number	Status (1)	Material type (2)	Package   Pins	Package qty   Carrier	RoHS (3)	Lead finish/ Ball material (4)	MSL rating/ Peak reflow (5)	Op temp (°C)	Part marking (6)
<a href="#">TPS53353DQPR</a>	Active	Production	LSON-CLIP (DQP)   22	2500   LARGE T&R	ROHS Exempt	NIPDAU   SN	Level-2-260C-1 YEAR	-40 to 125	53353DQP
TPS53353DQPR.Z	Active	Production	LSON-CLIP (DQP)   22	2500   LARGE T&R	ROHS Exempt	NIPDAU	Level-2-260C-1 YEAR	-40 to 125	53353DQP
TPS53353DQPRG4.Z	Active	Production	LSON-CLIP (DQP)   22	2500   LARGE T&R	ROHS Exempt	NIPDAU	Level-2-260C-1 YEAR	-40 to 125	53353DQP
<a href="#">TPS53353DQPT</a>	Active	Production	LSON-CLIP (DQP)   22	250   SMALL T&R	ROHS Exempt	NIPDAU   SN	Level-2-260C-1 YEAR	-40 to 125	53353DQP
TPS53353DQPT.Z	Active	Production	LSON-CLIP (DQP)   22	250   SMALL T&R	ROHS Exempt	NIPDAU	Level-2-260C-1 YEAR	-40 to 125	53353DQP

<sup>(1)</sup> **Status:** For more details on status, see our [product life cycle](#).

<sup>(2)</sup> **Material type:** When designated, preproduction parts are prototypes/experimental devices, and are not yet approved or released for full production. Testing and final process, including without limitation quality assurance, reliability performance testing, and/or process qualification, may not yet be complete, and this item is subject to further changes or possible discontinuation. If available for ordering, purchases will be subject to an additional waiver at checkout, and are intended for early internal evaluation purposes only. These items are sold without warranties of any kind.

<sup>(3)</sup> **RoHS values:** Yes, No, RoHS Exempt. See the [TI RoHS Statement](#) for additional information and value definition.

<sup>(4)</sup> **Lead finish/Ball material:** Parts may have multiple material finish options. Finish options are separated by a vertical ruled line. Lead finish/Ball material values may wrap to two lines if the finish value exceeds the maximum column width.

<sup>(5)</sup> **MSL rating/Peak reflow:** The moisture sensitivity level ratings and peak solder (reflow) temperatures. In the event that a part has multiple moisture sensitivity ratings, only the lowest level per JEDEC standards is shown. Refer to the shipping label for the actual reflow temperature that will be used to mount the part to the printed circuit board.

<sup>(6)</sup> **Part marking:** There may be an additional marking, which relates to the logo, the lot trace code information, or the environmental category of the part.

Multiple part markings will be inside parentheses. Only one part marking contained in parentheses and separated by a "-" will appear on a part. If a line is indented then it is a continuation of the previous line and the two combined represent the entire part marking for that device.

**Important Information and Disclaimer:** The information provided on this page represents TI's knowledge and belief as of the date that it is provided. TI bases its knowledge and belief on information provided by third parties, and makes no representation or warranty as to the accuracy of such information. Efforts are underway to better integrate information from third parties. TI has taken and continues to take reasonable steps to provide representative and accurate information but may not have conducted destructive testing or chemical analysis on incoming materials and chemicals. TI and TI suppliers consider certain information to be proprietary, and thus CAS numbers and other limited information may not be available for release.

In no event shall TI's liability arising out of such information exceed the total purchase price of the TI part(s) at issue in this document sold by TI to Customer on an annual basis.

**TAPE AND REEL INFORMATION**

**QUADRANT ASSIGNMENTS FOR PIN 1 ORIENTATION IN TAPE**

\*All dimensions are nominal

Device	Package Type	Package Drawing	Pins	SPQ	Reel Diameter (mm)	Reel Width W1 (mm)	A0 (mm)	B0 (mm)	K0 (mm)	P1 (mm)	W (mm)	Pin1 Quadrant
TPS53353DQPR	LSON-CLIP	DQP	22	2500	330.0	12.4	5.3	6.3	1.8	8.0	12.0	Q1
TPS53353DQPR	LSON-CLIP	DQP	22	2500	330.0	15.4	5.3	6.3	1.8	8.0	12.0	Q1
TPS53353DQPT	LSON-CLIP	DQP	22	250	180.0	12.4	5.3	6.3	1.8	8.0	12.0	Q1

**TAPE AND REEL BOX DIMENSIONS**

\*All dimensions are nominal

Device	Package Type	Package Drawing	Pins	SPQ	Length (mm)	Width (mm)	Height (mm)
TPS53353DQPR	LSON-CLIP	DQP	22	2500	346.0	346.0	33.0
TPS53353DQPR	LSON-CLIP	DQP	22	2500	336.6	336.6	41.3
TPS53353DQPT	LSON-CLIP	DQP	22	250	210.0	185.0	35.0

DQP (R-PSON-N22)

PLASTIC SMALL OUTLINE NO-LEAD

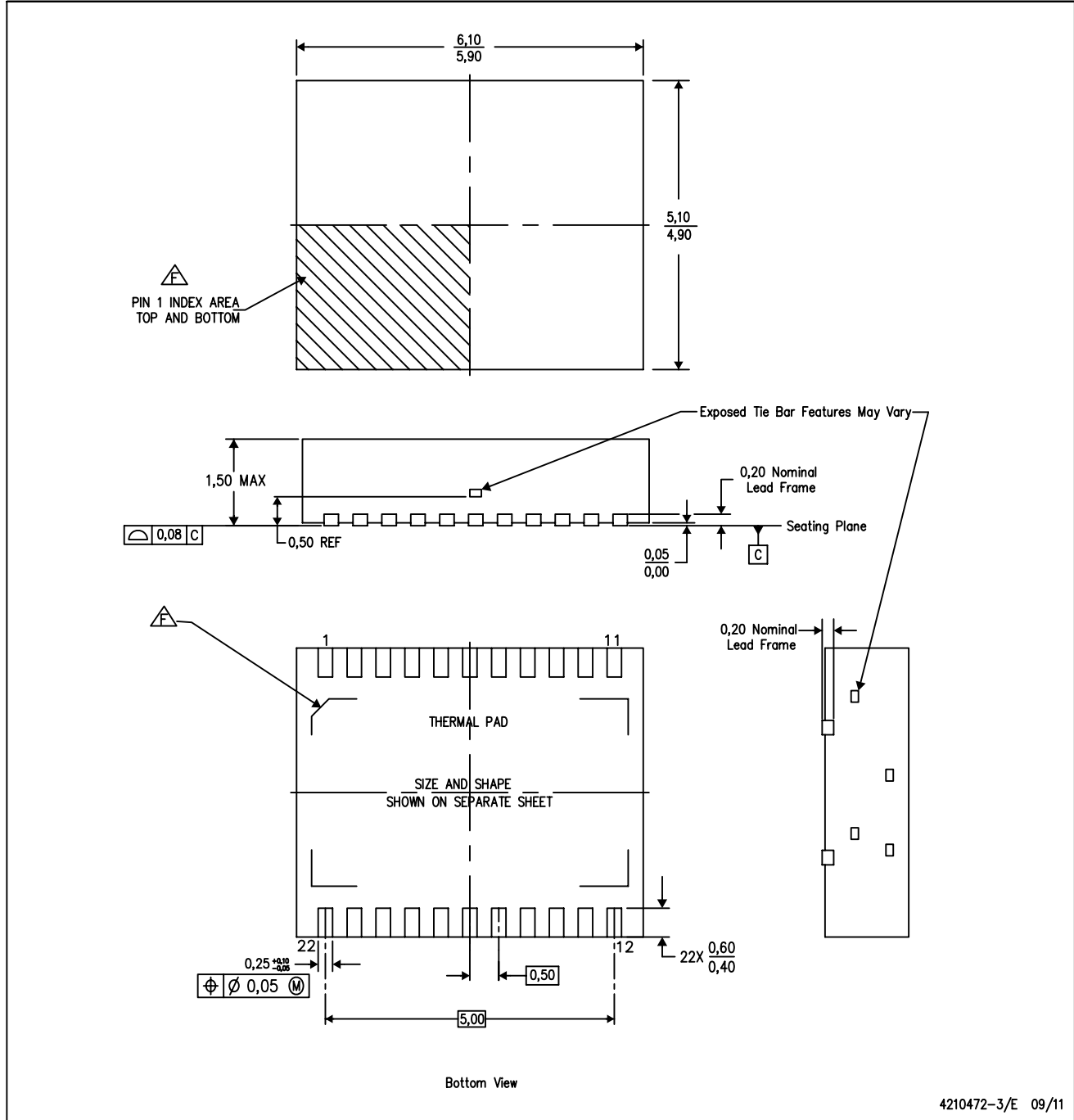

- NOTES:
- A. All linear dimensions are in millimeters. Dimensioning and tolerancing per ASME Y14.5M-1994.
  - B. This drawing is subject to change without notice.
  - C. Small Outline No-Lead (SON) package configuration.
  - D. The package thermal pad must be soldered to the board for thermal and mechanical performance.
  - E. See the additional figure in the Product Data Sheet for details regarding the exposed thermal pad features and dimensions.
  - F. Pin 1 identifiers are located on both top and bottom of the package and within the zone indicated. The Pin 1 identifiers are either a molded, marked, or metal feature.

# THERMAL PAD MECHANICAL DATA

DQP (R-PSO-N22)

PLASTIC SMALL OUTLINE NO-LEAD

## THERMAL INFORMATION

This package incorporates an exposed thermal pad that is designed to be attached directly to an external heatsink. The thermal pad must be soldered directly to the printed circuit board (PCB). After soldering, the PCB can be used as a heatsink. In addition, through the use of thermal vias, the thermal pad can be attached directly to the appropriate copper plane shown in the electrical schematic for the device, or alternatively, can be attached to a special heatsink structure designed into the PCB. This design optimizes the heat transfer from the integrated circuit (IC).

For information on the Quad Flatpack No-Lead (QFN) package and its advantages, refer to Application Report, QFN/SO-N PCB Attachment, Texas Instruments Literature No. SLUA271. This document is available at [www.ti.com](http://www.ti.com).

The exposed thermal pad dimensions for this package are shown in the following illustration.

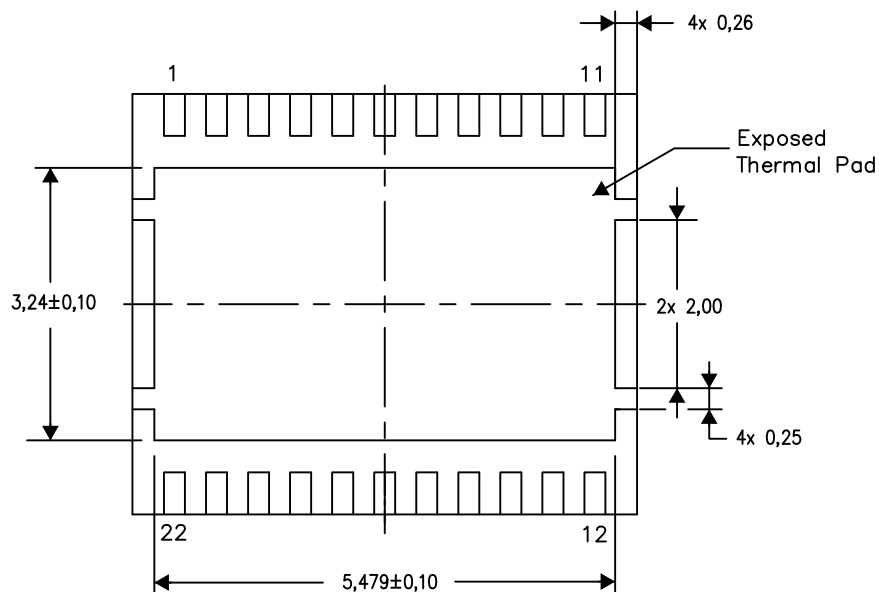

Bottom View

Exposed Thermal Pad Dimensions

4211024-3/H 08/15

NOTE: All linear dimensions are in millimeters

DQP (R-PSO-N22)

PLASTIC SMALL OUTLINE NO-LEAD

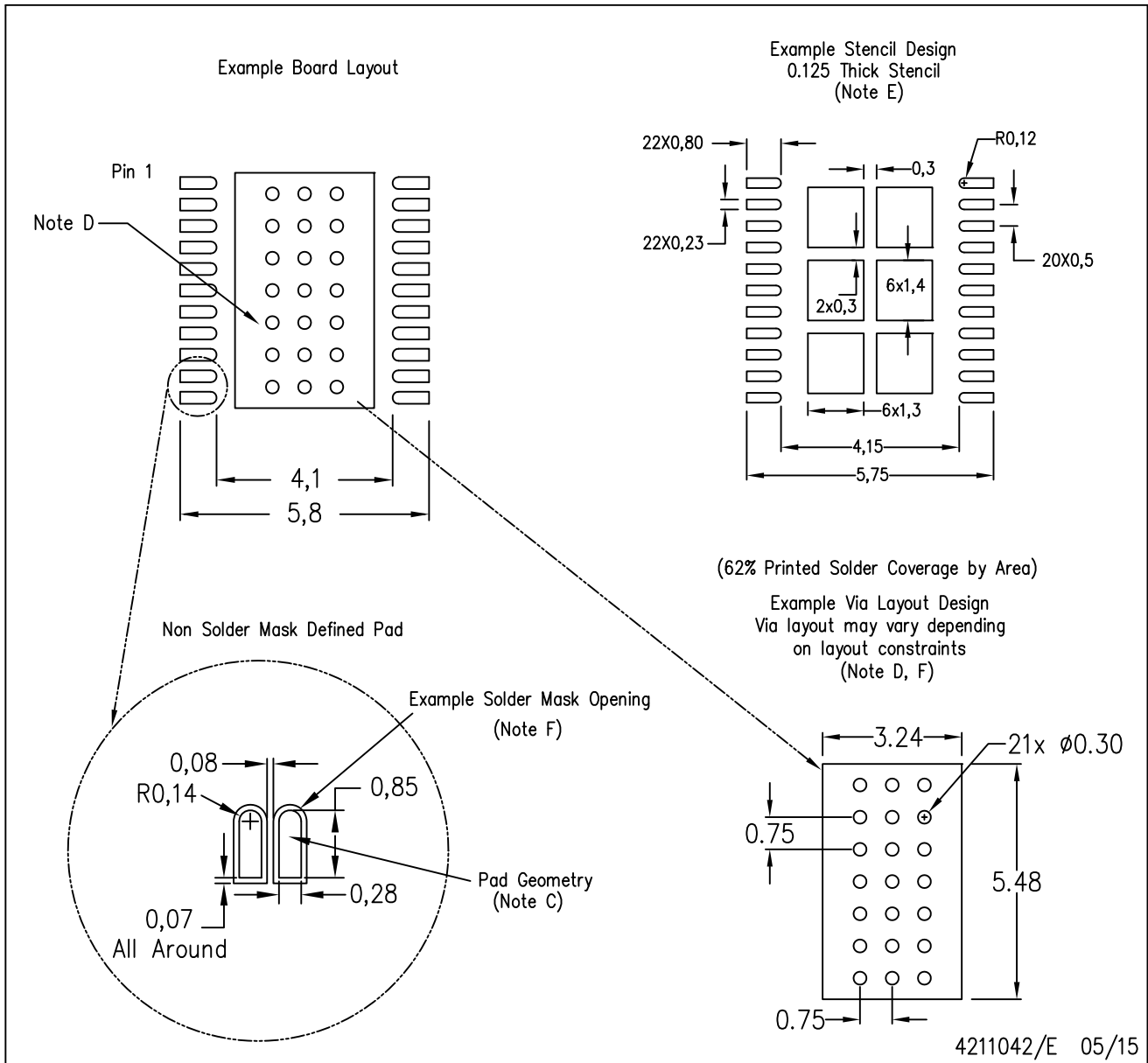

- NOTES:
- A. All linear dimensions are in millimeters.
  - B. This drawing is subject to change without notice.
  - C. Publication IPC-7351 is recommended for alternate designs.
  - D. This package is designed to be soldered to a thermal pad on the board. Refer to Application Note, QFN/SON PCB Attachment, Texas Instruments Literature No. SLUA271, and also the Product Data Sheets for specific thermal information, via requirements, and recommended board layout. These documents are available at [www.ti.com](http://www.ti.com) <<http://www.ti.com>>.
  - E. Laser cutting apertures with trapezoidal walls and also rounding corners will offer better paste release. Customers should contact their board assembly site for stencil design recommendations. Refer to IPC 7525 for stencil design considerations.
  - F. Customers should contact their board fabrication site for recommended solder mask tolerances and via tenting recommendations for vias placed in the thermal pad.

## 重要なお知らせと免責事項

テキサス・インスツルメンツは、技術データと信頼性データ(データシートを含みます)、設計リソース(リファレンス デザインを含みます)、アプリケーションや設計に関する各種アドバイス、Web ツール、安全性情報、その他のリソースを、欠陥が存在する可能性のある「現状のまま」提供しており、商品性および特定目的に対する適合性の黙示保証、第三者の知的財産権の非侵害保証を含むいかなる保証も、明示的または黙示的にかかわらず拒否します。

これらのリソースは、テキサス・インスツルメンツ製品を使用する設計の経験を積んだ開発者への提供を意図したものです。(1) お客様のアプリケーションに適したテキサス・インスツルメンツ製品の選定、(2) お客様のアプリケーションの設計、検証、試験、(3) お客様のアプリケーションに該当する各種規格や、その他のあらゆる安全性、セキュリティ、規制、または他の要件への確実な適合に関する責任を、お客様のみが単独で負うものとし、ます。

上記の各種リソースは、予告なく変更される可能性があります。これらのリソースは、リソースで説明されているテキサス・インスツルメンツ製品を使用するアプリケーションの開発の目的でのみ、テキサス・インスツルメンツはその使用をお客様に許諾します。これらのリソースに関して、他の目的で複製することや掲載することは禁止されています。テキサス・インスツルメンツや第三者の知的財産権のライセンスが付与されている訳ではありません。お客様は、これらのリソースを自身で使用した結果発生するあらゆる申し立て、損害、費用、損失、責任について、テキサス・インスツルメンツおよびその代理人を完全に補償するものとし、テキサス・インスツルメンツは一切の責任を拒否します。

テキサス・インスツルメンツの製品は、[テキサス・インスツルメンツの販売条件](#)、または [ti.com](https://www.ti.com) やかかるテキサス・インスツルメンツ製品の関連資料などのいずれかを通じて提供する適用可能な条項の下で提供されています。テキサス・インスツルメンツがこれらのリソースを提供することは、適用されるテキサス・インスツルメンツの保証または他の保証の放棄の拡大や変更を意味するものではありません。

お客様がいかなる追加条項または代替条項を提案した場合でも、テキサス・インスツルメンツはそれらに異議を唱え、拒否します。

郵送先住所：Texas Instruments, Post Office Box 655303, Dallas, Texas 75265  
Copyright © 2025, Texas Instruments Incorporated